

SAFETY PERFORMANCE EVALUATION OF THE NEBRASKA OPEN BRIDGE RAIL ON AN INVERTED TEE BRIDGE DECK

Submitted by

Karla A. Polivka, M.S.M.E., E.I.T.
Research Associate Engineer

John R. Rohde, Ph.D., P.E.
Associate Professor

Dean L. Sicking, Ph.D., P.E.
Professor and MwRSF Director

Ronald K. Faller, Ph.D., P.E.
Research Assistant Professor

John D. Reid, Ph.D.
Associate Professor

James C. Holloway, M.S.C.E., E.I.T.
Research Associate Engineer

MIDWEST ROADSIDE SAFETY FACILITY

University of Nebraska-Lincoln
527 Nebraska Hall
Lincoln, Nebraska 68588-0529
(402) 472-6864

Submitted to

NEBRASKA DEPARTMENT OF ROADS

1500 Nebraska Highway 2
Lincoln, Nebraska 68509-4759

MwRSF Research Report No. TRP-03-133-04

January 21, 2004

Technical Report Documentation Page

1. Report No.	2.	3. Recipient's Accession No.	
4. Title and Subtitle Safety Performance Evaluation of the Nebraska Open Bridge Rail on an Inverted Tee Bridge Deck		5. Report Date January 21, 2004	
		6.	
7. Author(s) Polivka, K.A., Faller, R.K., Rohde, J.R., Reid, J.D., Sicking, D.L., and Holloway, J.C.		8. Performing Organization Report No. TRP-03-133-04	
9. Performing Organization Name and Address Midwest Roadside Safety Facility (MwRSF) University of Nebraska-Lincoln 527 Nebraska Hall Lincoln, NE 68588-0529		10. Project/Task/Work Unit No.	
		11. Contract © or Grant (G) No.	
12. Sponsoring Organization Name and Address Nebraska Department of Roads 1500 Nebraska Highway 2 Lincoln, Nebraska 68509-4759		13. Type of Report and Period Covered Final Report 2001-2003	
		14. Sponsoring Agency Code	
15. Supplementary Notes Prepared in cooperation with U.S. Department of Transportation, Federal Highway Administration			
16. Abstract (Limit: 200 words) <p>Nebraska's Open Concrete Bridge Rail attached to an inverted tee bridge deck system was constructed and full-scale vehicle crash tested. The reinforcing design of the bridge rail attachment to the bridge deck was evaluated and redesigned prior to construction. With the redesigned reinforcement details, the 737-mm (29-in.) high bridge rail was constructed 29.57-m (97-ft) long with thirteen bridge posts, each measuring 279-mm (11-in.) wide x 610-mm (24-in.) long x 330-mm (13-in.) high. Post spacings were 2,438 mm (8 ft) on centers.</p> <p>A similar system with the bridge rail attached to the deck with vertical reinforcing bars tied to two layers of reinforcement in the bridge deck was previously certified to meet the Test Level 4 (TL-4) evaluation criteria specified in NCHRP Report No. 350 through testing according to AASHTO Performance Level 2 (PL-2) criteria. Due to this testing, the pickup truck test was the only test necessary to evaluate the safety performance of the bridge rail when attached to thin decks placed on inverted tee bridge girders. Therefore, the research study included one full-scale vehicle crash test using a ¾-ton pickup truck. The full-scale test, impacting at a speed of 99.8 km/hr (62.0 mph) and at an angle of 26.6 degrees, was conducted and reported in accordance with the requirements specified in the National Cooperative Highway Research Program (NCHRP) Report No. 350, <i>Recommended Procedures for the Safety Performance Evaluation of Highway Features</i>. The safety performance of the open concrete bridge rail attached to an inverted tee bridge deck was determined to be acceptable according to the TL-4 evaluation criteria specified in NCHRP Report No. 350.</p>			
17. Document Analysis/Descriptors Highway Safety, Open Concrete Bridge Rail, Inverted Tee Bridge Deck System, Roadside Appurtenances, Crash Test, Compliance Test		18. Availability Statement No restrictions. Document available from: National Technical Information Services, Springfield, Virginia 22161	
19. Security Class (this report) Unclassified	20. Security Class (this page) Unclassified	21. No. of Pages 94	22. Price

DISCLAIMER STATEMENT

The contents of this report reflect the views of the authors who are responsible for the facts and the accuracy of the data presented herein. The contents do not necessarily reflect the official views nor policies of the Nebraska Department of Roads nor the Federal Highway Administration. This report does not constitute a standard, specification, or regulation.

ACKNOWLEDGMENTS

The authors wish to acknowledge several sources that made a contribution to this project:

(1) the Nebraska Department of Roads for sponsoring this project and supplying the inverted tee sections; and (2) MwRSF personnel for constructing the bridge rail and conducting the crash test.

A special thanks is also given to the following individuals who made a contribution to the completion of this research project.

Midwest Roadside Safety Facility

R.W. Bielenberg, M.S.M.E., Research Associate Engineer
A.T. Russell, Laboratory Mechanic II
M.L. Hanau, Laboratory Mechanic I
G.L. Schmutte, former Laboratory Mechanic I
Undergraduate and Graduate Assistants

Nebraska Department of Roads

Gale Barhill, P.E., Bridge Division
Hussam “Sam” Fallaha, P.E., Bridge Division, Assistant Bridge Engineer
Mark Traynowicz, P.E., Transportation Planning Manager
Phil Tenhulzen, P.E., Design Standards Engineer

Tadros Associates, L.L.C.

Scott Gilliland, P.E.
Maher Tadros, Ph.D., P.E.

Federal Highway Administration

John Perry, P.E., Nebraska Division Office
Danny Briggs, Nebraska Division Office

Dunlap Photography

James Dunlap, President and Owner

TABLE OF CONTENTS

	Page
TECHNICAL REPORT DOCUMENTATION PAGE	i
DISCLAIMER STATEMENT	ii
ACKNOWLEDGMENTS	iii
TABLE OF CONTENTS	iv
List of Figures	vi
List of Tables	viii
1 INTRODUCTION	1
1.1 Problem Statement	1
1.2 Objective	1
1.3 Scope	2
2 LITERATURE REVIEW	3
3 TEST REQUIREMENTS AND EVALUATION CRITERIA	6
3.1 Test Requirements	6
3.2 Evaluation Criteria	7
4 DESIGN DETAILS	10
4.1 Bridge Substructure	10
4.2 Bridge Rail	11
5 TEST CONDITIONS	29
5.1 Test Facility	29
5.2 Vehicle Tow and Guidance System	29
5.3 Test Vehicles	29
5.4 Data Acquisition Systems	32
5.4.1 Accelerometers	32
5.4.2 Rate Transducers	34
5.4.3 High-Speed Photography	34
5.4.4 Pressure Tape Switches	35
6 CRASH TEST NO. 1	37
6.1 Test NIT-1	37
6.2 Test Description	37
6.3 Barrier Damage	38

6.4 Vehicle Damage	40
6.5 Occupant Risk Values	41
6.6 Discussion	41
7 SUMMARY AND CONCLUSIONS	64
8 RECOMMENDATIONS	66
9 REFERENCES	67
10 APPENDICES	68
APPENDIX A - English-Unit System Drawings and Nebraska’s Standard Plans	69
APPENDIX B - Test Summary Sheet in English Units, Test NIT-1	81
APPENDIX C - Occupant Compartment Deformation Data, Test NIT-1	83
APPENDIX D - Accelerometer Data Analysis, Test NIT-1	85
APPENDIX E - Roll and Yaw Data Analysis, Test NIT-1	92

List of Figures

	Page
1. Layout for Open Concrete Bridge Rail Attached to Inverted Tee Bridge Deck System	14
2. Bridge Rail Profile Details	15
3. Inverted Tee Bridge Deck System Reinforcement Details	16
4. Abutment Details	17
5. Abutment Joint Details	18
6. Bent Details	19
7. Bent Joint Details	20
8. OCR Bridge Rail on Inverted Tee Bridge Deck Bill of Bars	21
9. Concrete Girders	22
10. Lateral Stiffener End Caps at Upstream and Downstream Abutment Joints	23
11. Lateral Stiffener End Caps at Bent Joints	24
12. Bridge Deck	25
13. Open Concrete Bridge Rail	26
14. Open Concrete Bridge Rail	27
15. Bridge Rail and Posts	28
16. Test Vehicle, Test NIT-1	30
17. Vehicle Dimensions, Test NIT-1	31
18. Vehicle Target Locations, Test NIT-1	33
19. Location of High-Speed Cameras, Test NIT-1	36
20. Summary of Test Results and Sequential Photographs, Test NIT-1	42
21. Additional Sequential Photographs, Test NIT-1	43
22. Additional Sequential Photographs, Test NIT-1	44
23. Perpendicular Documentary Photographs, Test NIT-1	45
24. Downstream Documentary Photographs, Test NIT-1	46
25. Downstream Documentary Photographs, Test NIT-1	47
26. Downstream Documentary Photographs, Test NIT-1	48
27. Impact Location, Test NIT-1	49
28. Vehicle Final Position and Trajectory Marks, Test NIT-1	50
29. Open Concrete Bridge Rail System Damage, Test NIT-1	51
30. Open Concrete Bridge Rail System Damage, Test NIT-1	52
31. Open Concrete Bridge Rail Post Damage, Test NIT-1	53
32. Open Concrete Bridge Rail Damage, Test NIT-1	54
33. Open Concrete Bridge Rail Damage, Test NIT-1	55
34. Bridge Deck Damage Around Post No. 5, Test NIT-1	56
35. Bridge Deck Damage Around Post No. 6, Test NIT-1	57
36. Bridge Deck Damage Around Post No. 7, Test NIT-1	58
37. Vehicle Damage, Test NIT-1	59
38. Vehicle Damage, Test NIT-1	60
39. Vehicle Undercarriage Damage, Test NIT-1	61
40. Windshield Damage, Test NIT-1	62
41. Occupant Compartment Damage, Test NIT-1	63

A-1. Layout for Open Concrete Bridge Rail Attached to Inverted Tee Bridge Deck System (English)	70
A-2. Bridge Rail Profile Details (English)	71
A-3. Inverted Tee Bridge Deck System Reinforcement Details (English)	72
A-4. Abutment Details (English)	73
A-5. Abutment Joint Details (English)	74
A-6. Bent Details (English)	75
A-7. Bent Joint Details (English)	76
A-8. OCR Bridge Rail on Inverted Tee Bridge Deck Bill of Bars (English)	77
A-9. NDOR's Bridge Deck Standard Plan (English)	78
A-10. NDOR's Open Concrete Bridge Rail Standard Plans (English)	79
A-11. NDOR's Inverted Tee Standard Plans (English)	80
B-1. Summary of Test Results and Sequential Photographs (English), Test NIT-1	82
C-1. Occupant Compartment Deformation Data, Test NIT-1	84
D-1. Graph of Longitudinal Deceleration Test NIT-1	86
D-2. Graph of Longitudinal Occupant Impact Velocity, Test NIT-1	87
D-3. Graph of Longitudinal Occupant Displacement, Test NIT-1	88
D-4. Graph of Lateral Deceleration, Test NIT-1	89
D-5. Graph of Lateral Occupant Impact Velocity, Test NIT-1	90
D-6. Graph of Lateral Occupant Displacement, Test NIT-1	91
E-1. Graph of Roll Angular Displacements, Test NIT-1	93
E-2. Graph of Yaw Angular Displacements, Test NIT-1	94

List of Tables

Page

1. NCHRP Report No. 350 Test Level 4 Crash Test Conditions 8
2. NCHRP Report No. 350 Evaluation Criteria for Crash Tests 9
3. Summary of Safety Performance Evaluation Results 65

1 INTRODUCTION

1.1 Problem Statement

Typically, Nebraska's open concrete bridge rail is attached to a bridge deck with vertical reinforcing bars that are tied to two layers of bridge deck reinforcement. However, bridge decks placed on inverted tee girders are much thinner and utilize a single layer of reinforcement in the center of the slab. This deck configuration precludes utilizing the same attachment between the bridge railing and the concrete bridge deck.

In 1996, the Nebraska Department of Road's (NDOR's) Open Concrete Bridge Rail was successfully crash tested (1-2) according to the American Association of State Highway and Transportation Official's (AASHTO's) Performance Level 2 (PL-2) criteria (3). Subsequently, the Federal Highway Administration (FHWA) grandfathered the approval of NDOR's Open Concrete Bridge Rail to the Test Level 4 (TL-4) safety performance criteria of the National Cooperative Highway Research Program (NCHRP) Report No. 350, *Recommended Procedures for the Safety Performance Evaluation of Highway Features* (4). Although this bridge railing system had been certified as meeting the NCHRP Report No. 350 TL-4 safety performance criteria and has performed acceptably in the field, no full-scale vehicle crash tests have been conducted on the railing system when attached to thin decks placed on inverted tee bridge girders. Therefore, a need existed to evaluate the structural capacity of the post-to-deck connection as well as the system's safety performance under NCHRP Report No. 350 impact requirements.

1.2 Objective

The objective of the research project was to evaluate the safety performance of NDOR's Open Concrete Bridge Rail when installed on a thin, reinforced concrete bridge deck utilizing an

inverted tee girder system. The bridge rail was to be evaluated according to the TL-4 safety performance criteria set forth in the NCHRP Report No. 350.

1.3 Scope

The research objective was achieved by performing several tasks. First, an analysis phase on the bridge rail's post-to-deck attachment was conducted in order to estimate the dynamic load capacity and the extent of damage that would be expected during high-energy impacts. Next, a brainstorming session was conducted between engineers from MwRSF, Tadros Associates, and NDOR's Bridge Rail Division in order to finalize bridge deck reinforcement details. Subsequently, a full-size test bridge system was constructed at MwRSF's outdoor test facility. Following the fabrication of the bridge system, a full-scale vehicle crash test was performed using a ¾-ton pickup truck, weighing approximately 2,000 kg (4,409 lbs), with a target impact speed and an angle of 100.0 km/hr (62.1 mph) and 25 degrees, respectively. Finally, the test results were analyzed, evaluated, and documented. Conclusions and recommendations were then made that pertain to the safety performance of the open concrete bridge rail attached to an inverted tee bridge deck system.

2 LITERATURE REVIEW

In 1986, ENSCO, Inc. of Springfield, Virginia, conducted two full-scale vehicle crash tests on NDOR's open concrete bridge rail (5). The open concrete bridge rail was constructed with a 356-mm (14-in.) wide by 406-mm (16-in.) deep rail containing No. 6 longitudinal reinforcement bars. The rail was supported by concrete posts, measuring 279-mm (11-in.) wide by 279-mm (11-in.) long by 330-mm (13-in.) high, that contained No. 7 vertical reinforcement bars. The posts were spaced 2.3 m (7.5 ft) on centers. Although the open concrete bridge rail design incorporated a 76 mm (3 in.) expansion gap, the simulated bridge rail used in testing did not contain an expansion gap.

The bridge rail system was tested according to the evaluation criteria of NCHRP Report No. 230, *Recommended Procedures for the Safety Performance Evaluation of Highway Features* (6). Test no. 1769-F-1-86 was conducted with a 2,118-kg (4,669-lb) sedan impacting at a speed of 92.7 km/hr (57.6 mph) and at an angle of 26 degrees. Test no. 1769-F-2-86 involved an 894-kg (1,971-lb) small car impacting at a speed of 95.9 km/hr (59.6 mph) and at an angle of 21 degrees. Both the small car and the sedan full-scale vehicle crash tests met the NCHRP Report No. 230 criteria and consequently, demonstrated that the geometry of 737-mm (29-in.) open concrete bridge rail could safely accommodate mini-sized and full-sized sedans.

In 1991, the Midwest Roadside Safety Facility (MwRSF) conducted two full-scale vehicle crash tests on a similar open concrete bridge rail design (7). The open concrete bridge rail was constructed with a 356-mm (14-in.) wide by 406-mm (16-in.) deep rail containing No. 5 longitudinal reinforcement bars. The rail included a 76 mm (3 in.) expansion gap and was supported by two different sized concrete posts. The two posts adjacent to the expansion gap measured 279-mm (11-in.) wide by 914-mm (36-in.) long by 330-mm (13-in.) high and contained three No. 4 and four

No. 6 reinforcement bars in the back- and traffic-side faces, respectively. The remaining posts measured 279-mm (11-in.) wide by 610-mm (24-in.) long by 330-mm (13-in.) high and contained five No. 6 reinforcement bars in both the back- and traffic-side faces.

The bridge rail system was tested according to the AASHTO PL-1 evaluation criteria (3). Test no. NEOCR-1, which involved a 2,404-kg (5,230-lb) pickup truck impacting at a speed of 76.8 km/hr (47.7 mph) and at an angle of 20.0 degrees, was conducted upstream of the expansion gap to investigate the structural adequacy of the posts and the snag potential on the downstream face of the expansion gap. Test no. NEOCR-2, which involved a 2,445-kg (5,390-lb) pickup truck impacting at a speed of 73.8 km/hr (45.9 mph) and at an angle of 20.0 degrees, was conducted at a midspan between two posts on the continuous rail section to investigate the structural adequacy of the economically reduced reinforcement rail. Both of the pickup truck full-scale vehicle crash tests met the AASHTO PL-1 evaluation criteria.

In 1996, MwRSF also conducted four full-scale vehicle crash tests on the open concrete rail design according to the AASHTO PL-2 evaluation criteria (1-2). Test nos. NEOCR-3, which involved an 8,165-kg (18,000-lb) single-unit truck impacting at a speed of 78.1 km/hr (48.5 mph) and at an angle of 17.1 degrees, and NEOCR-6, which involved a 2,449-kg (5,399-lb) pickup truck impacting at a speed of 98.2 km/hr (61.0 mph) and at an angle of 20.0 degrees, were conducted upstream of the expansion gap to investigate the safety performance of the discontinuous rail section. Test nos. NEOCR-4, which involved an 8,165-kg (18,000-lb) single-unit truck impacting at a speed of 83.5 km/hr (51.9 mph) and at an angle of 16.8 degrees, and NEOCR-5, which involved a 2,447-kg (5,395-lb) pickup truck impacting at a speed of 96.2 km/hr (59.8 mph) and at an angle of 21.7 degrees, were conducted between two posts on the continuous rail section to investigate the

structural adequacy and redirection capacity of the continuous rail section. Both single-unit trucks were smoothly redirected without any tendency to rollover, and the structural adequacy of the rail was maintained. Both pickup trucks sustained moderate occupant compartment damage, but the occupant compartment integrity was maintained. Therefore, the single-unit and pickup truck full-scale vehicle crash tests met the AASHTO PL-2 evaluation criteria. As previously mentioned, FHWA later provided an equivalent rating of TL-4 to this bridge railing system.

3 TEST REQUIREMENTS AND EVALUATION CRITERIA

3.1 Test Requirements

Longitudinal barriers, such as open concrete bridge rails, must satisfy the requirements provided in NCHRP Report No. 350 to be accepted for use on National Highway System (NHS) construction projects or as a replacement for existing systems not meeting current safety standards. According to TL-4 of NCHRP Report No. 350, the bridge railing system must be subjected to three full-scale vehicle crash tests. The three crash tests are as follows:

1. Test Designation 4-10. An 820-kg (1,808-lb) small car impacting the bridge rail system at a nominal speed and angle of 100.0 km/hr (62.1 mph) and 20 degrees, respectively.
2. Test Designation 4-11. A 2,000-kg (4,409-lb) pickup truck impacting the bridge rail system at a nominal speed and angle of 100.0 km/hr (62.1 mph) and 25 degrees, respectively.
3. Test Designation 4-12. An 8,000-kg (17,637-lb) single-unit truck impacting the bridge rail system at a nominal speed and angle of 80.0 km/hr (49.7 mph) and 15 degrees, respectively.

Although the small car test is used to evaluate the overall performance of the length-of-need section and occupant risk problems arising from the snagging or overturning of the vehicle, it was deemed unnecessary through previous testing on a similar system. Performed by ENSCO, Inc. (5), a similar bridge rail system with the same effective railing height and shape of railing face had been successfully tested in accordance with the performance criteria of NCHRP Report No. 230, *Recommended Procedures for the Safety Performance Evaluation of Highway Appurtenances* (6). Therefore, on the basis of the previous test results, the 820-kg (1,808-lb) small car crash test was considered unnecessary for this project.

In addition, this bridge rail system has been successfully tested by MwRSF (1) according to

the PL-2 performance criteria provided in AASHTO's *Guide Specifications for Bridge Rails*. It should be noted that the AASHTO PL-2 and NCHRP Report No. 350 TL-4 impact conditions for the single-unit truck are identical. In addition, the pickup and single-unit trucks impart similar loading to a bridge railing system, but the pickup truck is believed to provide a more concentrated dynamic impulse to the structure. Therefore, on the basis of the previous test results and this belief, the single-unit truck crash test was also considered unnecessary for this project. Consequently, only the pickup truck impact condition was deemed necessary for this project since it is believed to impart the maximum dynamic lateral loading into the bridge rail system and any effects of deck performance will be critical in this test. The test conditions for TL-4 longitudinal barriers are summarized in Table 1.

3.2 Evaluation Criteria

Evaluation criteria for full-scale vehicle crash testing are based on three appraisal areas: (1) structural adequacy; (2) occupant risk; and (3) vehicle trajectory after collision. Criteria for structural adequacy are intended to evaluate the ability of the bridge railing to contain, redirect, or allow controlled vehicle penetration in a predictable manner. Occupant risk evaluates the degree of hazard to occupants in the impacting vehicle. Vehicle trajectory after collision is a measure of the potential for the post-impact trajectory of the vehicle to cause subsequent multi-vehicle accidents. This criterion also indicates the potential safety hazard for the occupants of other vehicles or the occupants of the impacting vehicle when subjected to secondary collisions with other fixed objects. These three evaluation criteria are defined in Table 2. The full-scale vehicle crash test was conducted and reported in accordance with the procedures provided in NCHRP Report No. 350.

Table 1. NCHRP Report No. 350 Test Level 4 Crash Test Conditions

Test Article	Test Designation	Test Vehicle	Impact Conditions			Evaluation Criteria ¹
			Speed		Angle (degrees)	
			(km/hr)	(mph)		
Longitudinal Barrier	4-10	820C	100	62.1	20	A,D,F,H,I,K,M
	4-11	2000P	100	62.1	25	A,D,F,K,L,M
	4-12	8000S	80	49.7	15	A,D,G,K,M

¹ Evaluation criteria explained in Table 2.

Table 2. NCHRP Report No. 350 Evaluation Criteria for Crash Tests (4)

Structural Adequacy	A. Test article should contain and redirect the vehicle; the vehicle should not penetrate, underride, or override the installation although controlled lateral deflection of the test article is acceptable.
Occupant Risk	D. Detached elements, fragments or other debris from the test article should not penetrate or show potential for penetrating the occupant compartment, or present an undue hazard to other traffic, pedestrians, or personnel in a work zone. Deformations of, or intrusions into, the occupant compartment that could cause serious injuries should not be permitted.
	F. The vehicle should remain upright during and after collision although moderate roll, pitching, and yawing are acceptable.
	G. It is preferable, although not essential, that the vehicle remain upright during and after collision.
	H. Longitudinal and lateral occupant impact velocities should fall below the preferred value of 9 m/s (29.53 ft/s), or at least below the maximum allowable value of 12 m/s (39.37 ft/s).
	I. Longitudinal and lateral occupant ridedown accelerations should fall below the preferred value of 15 g's, or at least below the maximum allowable value of 20 g's.
Vehicle Trajectory	K. After collision it is preferable that the vehicle's trajectory not intrude into adjacent traffic lanes.
	L. The occupant impact velocity in the longitudinal direction should not exceed 12 m/sec (39.37 ft/sec), and the occupant ridedown acceleration in the longitudinal direction should not exceed 20 G's.
	M. The exit angle from the test article preferably should be less than 60 percent of test impact angle measured at time of vehicle loss of contact with test device.

4 DESIGN DETAILS

The test installation consisted of a reinforced, open concrete bridge rail attached to an inverted tee bridge deck system, as shown in Figures 1 through 8. The corresponding English-unit drawings along with NDOR's standard plans are shown in Appendix A. Photographs of the test installation are shown in Figures 9 through 15.

4.1 Bridge Substructure

A concrete bearing pad, measuring 457-mm (18-in.) wide by 291-mm (11 ½-in.) thick by 2,134-mm (84-in.) long, was added to the top of each existing concrete bridge abutment and bent. No. 6 vertical steel bars, measuring 762-mm (30-in.) long, were doweled and epoxied into the top of each concrete bearing pad, as shown in Figures 4 and 6. A 6-mm (¼-in.) thick piece of plywood was placed between the existing concrete bridge abutments/bents and each concrete bearing pad to act as a bond breaker.

Two IT-500 prestressed concrete girders, spanning between any two concrete bridge supports, were placed on top of the concrete bridge abutments and bents. Each concrete girder measured 600-mm (23 ⅝-in.) wide by 140-mm (5 ½-in.) high at the base and 160-mm (6 5/16-in.) wide by 398-mm (14 3/16-in.) high along the stem and were 11.89-m (39-ft) long, as shown in Figure 9. NDOR's design and reinforcement details for the girders are shown in Appendix A. Neoprene bearing pads, measuring 6-mm (¼-in.) thick, were placed between the concrete girders and the concrete bearing pads. Lateral stiffener caps were then cast-in-place between the ends of concrete girders along the bents and the downstream abutment. The reinforcement details for the caps are shown in Figures 5, 7, 10, and 11.

The bridge deck measured 1,829-mm (72-in.) wide by 152-mm (6-in.) thick by 31.95-m

(104-ft 10-in.) long. The overall distance between the top of the bridge deck and the top of the existing concrete bridge supports was 981 mm (38 5/8 in.). The concrete used for the concrete deck consisted of a Nebraska 47-BD Mix Type 3, with a minimum compressive strength of 31.03 MPa (4,500 psi). The 28-day concrete compressive strength for the bridge deck, as determined from concrete cylinder testing, was found to be approximately 29.70 MPa (4,308 psi). A minimum concrete cover of 64 mm (2 1/2 in.) was used for all of the rebar placed within the bridge deck. All steel reinforcement in the bridge deck, with the exception of the short bars embedded in the apron, was Grade 60 epoxy-coated rebar. The short bars were Grade 60 non-epoxy coated steel.

The steel reinforcement for the bridge deck utilized No. 5 bars for the longitudinal and transverse bars. Each of the six longitudinal rebar in the bridge deck was 38.71-m (127-ft) long and spaced 305 mm (12 in.) on center, as shown in Figure 3. The length of the longitudinal bar can be varied as long as the minimum lap length of 762 mm (30 in.) is maintained. The transverse bars in the bridge deck were 1,753-mm (69-in.) long and spaced 305 mm (12 in.) on center, as shown in Figure 3. In addition, 1,219-mm (48-in.) long transverse bars were embedded 610 mm (24 in.) into the existing apron. These bars were then lapped 610 mm (24 in.) and tied to the appropriate transverse deck bars that corresponded to their spacing of 610 mm (24 in.) on center. Bridge deck reinforcement details are shown in Figures 3, 5, 7, and 8 and in Appendix A.

4.2 Bridge Rail

The 29.57-m (97-ft) long reinforced open concrete bridge rail was 356-mm (14-in.) wide by 406-mm (16-in.) deep with a 737-mm (29-in.) top mounting height, as measured from the top of the concrete deck to the top of the rail. The bridge rail was cast in placed on top of the concrete bridge posts with a 51-mm (2-in.) and 25-mm (1-in.) overhang on the front and back sides of the posts,

respectively. Thirteen bridge posts, measuring 279-mm (11-in.) wide by 610-mm (24-in.) long by 330-mm (13-in.) high, were used to support the bridge rail. Bridge posts were spaced 2,438 mm (8 ft) on centers along the length of the bridge railing, except at the upstream end where the first two posts were spaced 2,134 mm (7 ft) on center, as shown in Figure 1.

The concrete used for the bridge rail and posts consisted of Nebraska 47-BD Mix Type 3, with a minimum compressive strength of 31.03 MPa (4,500 psi). The 28-day concrete compressive strength for the bridge rail and posts, as determined from concrete cylinder testing, was found to be approximately 46.28 MPa (6,712 psi). A minimum concrete cover of 51 mm (2 in.) was used for all of the rebar placed within the bridge rail and posts. All steel reinforcement in the bridge rail and posts was Grade 60 epoxy-coated rebar. The bridge rail and post reinforcement details are shown in Appendix A.

The steel reinforcement for the bridge rail utilized No. 5 longitudinal bars and No. 3 vertical loop bars. Each of the six longitudinal rebar was 36.12-m (118-ft 6-in.) long with two 610-mm (24-in.) long laps along each one. The transverse and vertical spacings of the longitudinal bars were 254 mm (10 in.) and 152 mm (6 in.) on center, respectively. The vertical loop bars were 1,295-mm (51-in.) long and were bent into a rectangular shape. Their spacings varied longitudinally, as shown in Appendix A. The spacing of the vertical loop bars on either side of a bridge post was 762 mm (30 in.) on center. Between two posts, the spacing of the rail loop bars was 559 mm (22 in.) on center.

The steel reinforcement for the bridge posts consisted of No. 3 bars for the horizontal loop bars and No. 4 and 6 bars for the vertical L-shaped bars, as shown in Figure 2. The horizontal loop bars were 1,549-mm (61-in.) long and were bent into a rectangular shape. The vertical spacings of the post loop bars was 114 mm (4 ½ in.) on center. The post-to-deck attachment utilized eight

vertical, L-shaped bars in each post, as shown in Figure 2. The four No. 4 bars utilized on the back face were 1,118-mm (44-in.) long, while the four No. 6 bars utilized on the front face were 1,321-mm (52-in.) long. The longitudinal and transverse spacings of the vertical, L-shaped bars were approximately 165 mm (6 ½ in.) and 178 mm (7 in.) on center, respectively.

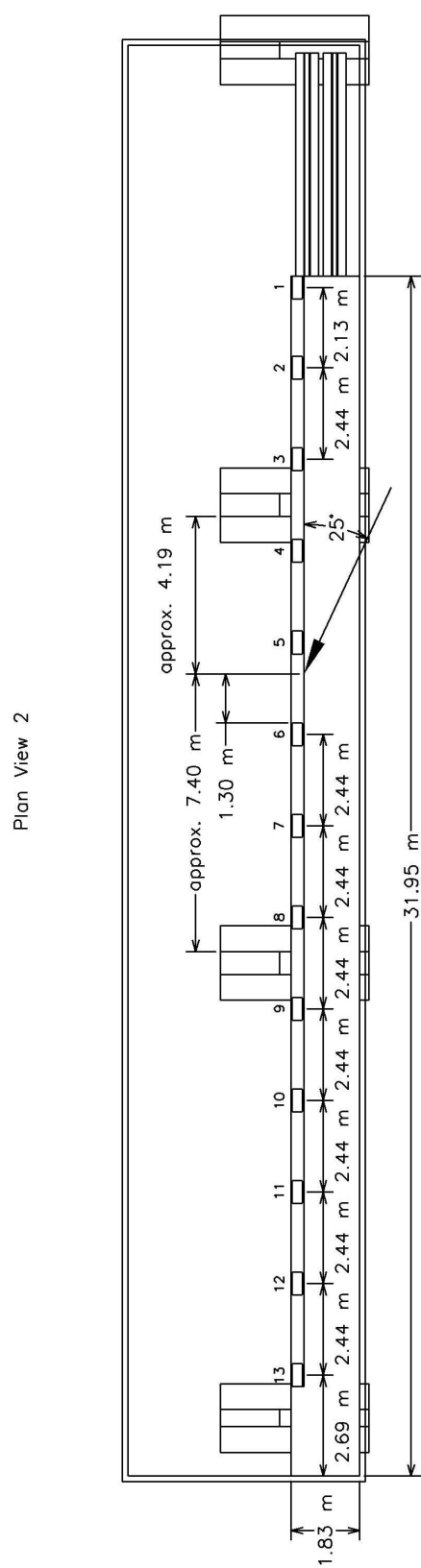
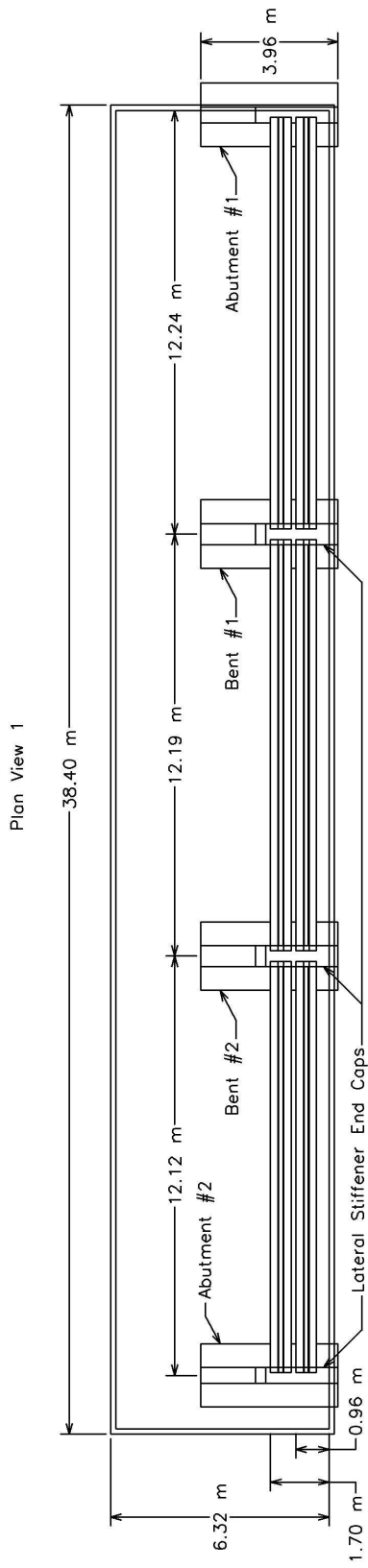
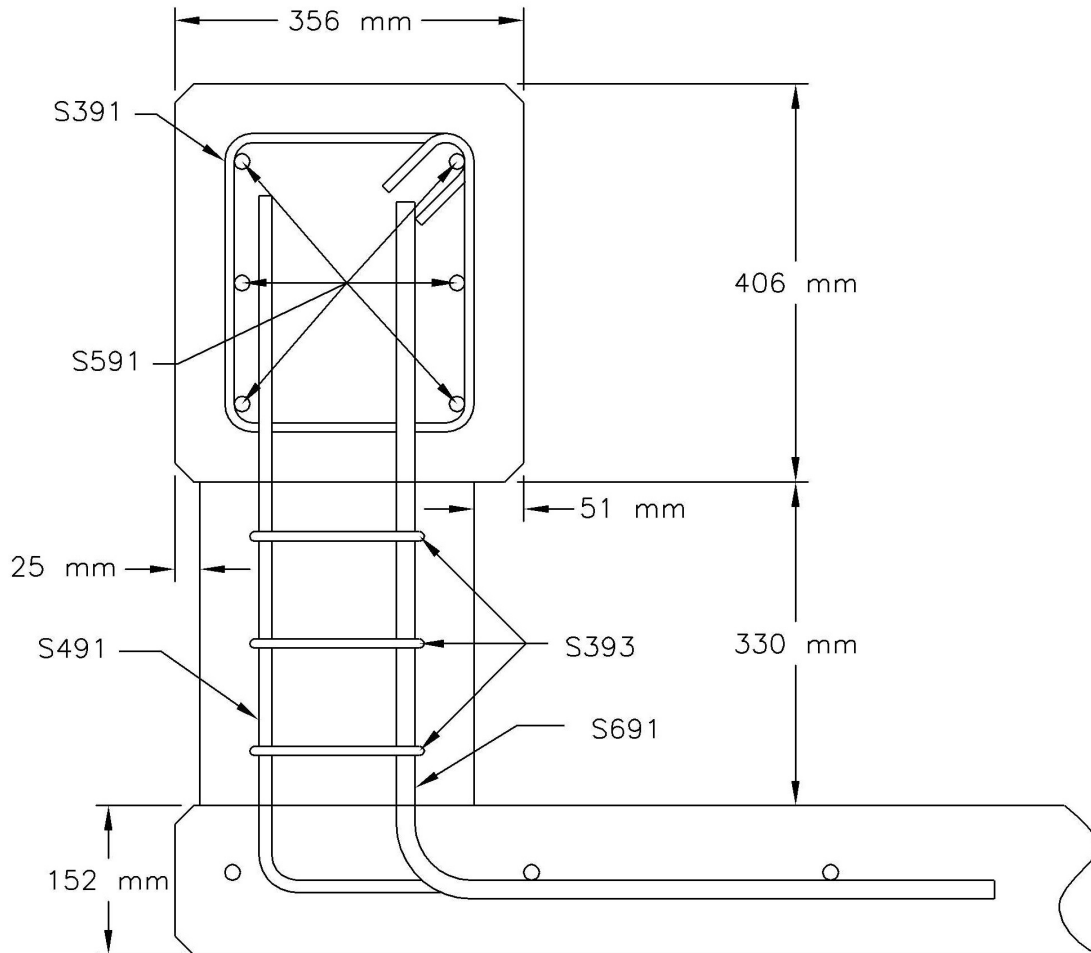

Figure 1. Layout for Open Concrete Bridge Rail Attached to Inverted Tee Bridge Deck System



NOTES:

- (1) USE GRADE 60 REINFORCING STEEL
- (2) USE NEBRASKA 47-BD TYPE 3 CONCRETE MIX DESIGN WITH 31.03 MPA MINIMUM 28-DAY CONCRETE COMPRESSIVE STRENGTH
- (3) USE 610 MM MINIMUM BAR LAP FOR ALL LONGITUDINAL AND TRANSVERSE BARS
- (4) USE 51 MM CONCRETE COVER FOR ALL CONSTRUCTION

Figure 2. Bridge Rail Profile Details

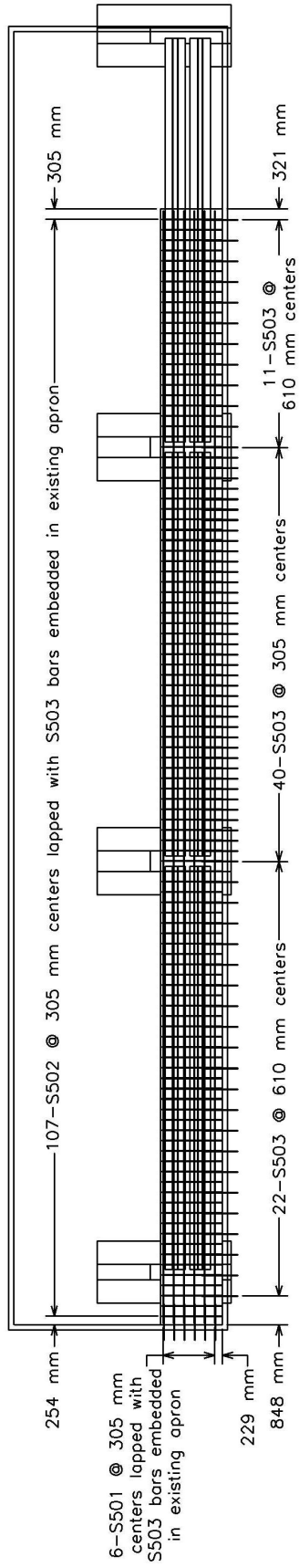

- Note:
- 1) All S503 bars embedded 610 mm into existing apron
 - 2) S503 bars lapped 610 mm with either S501 or S502 bars

Figure 3. Inverted Tee Bridge Deck System Reinforcement Details

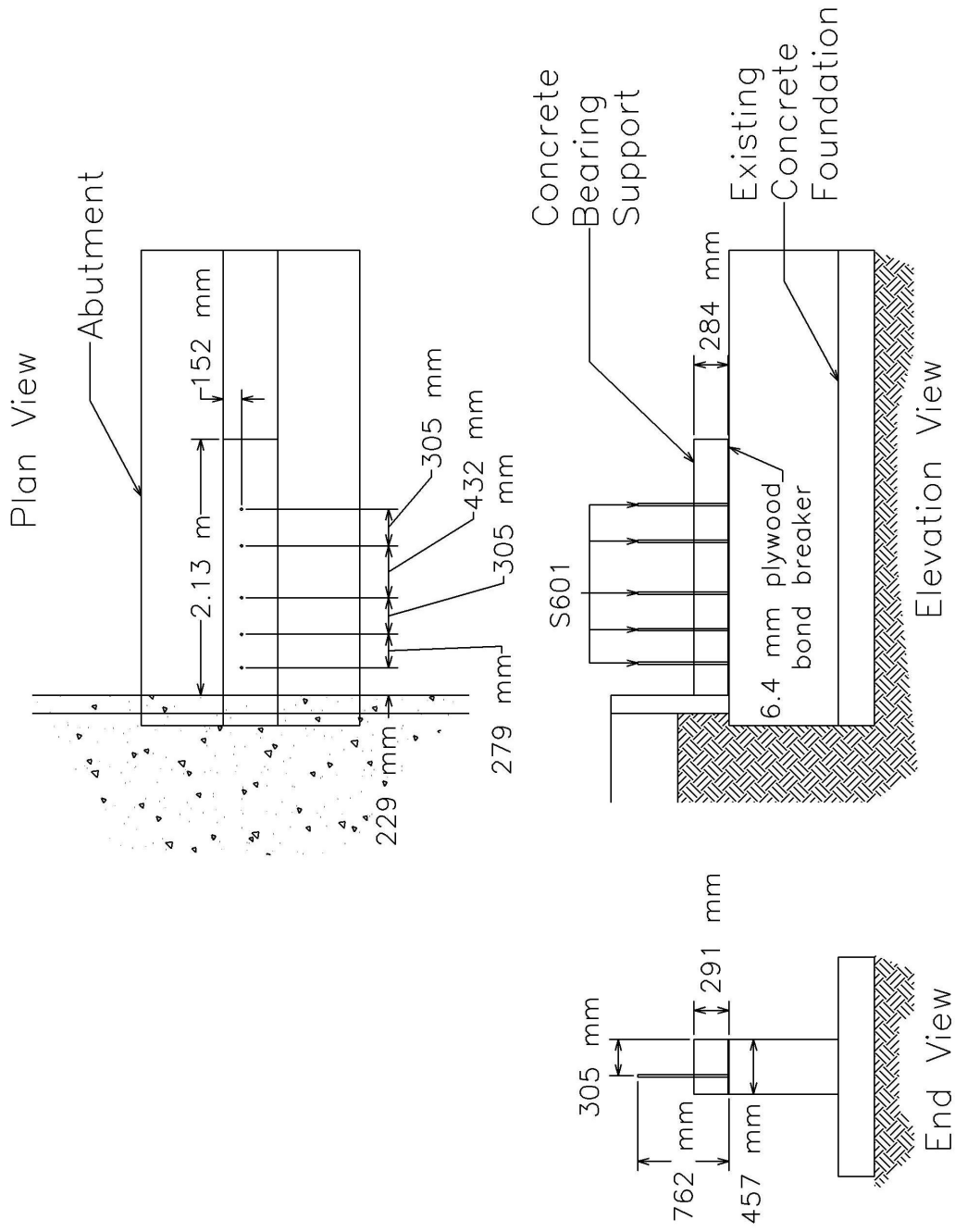

Figure 4. Abutment Details

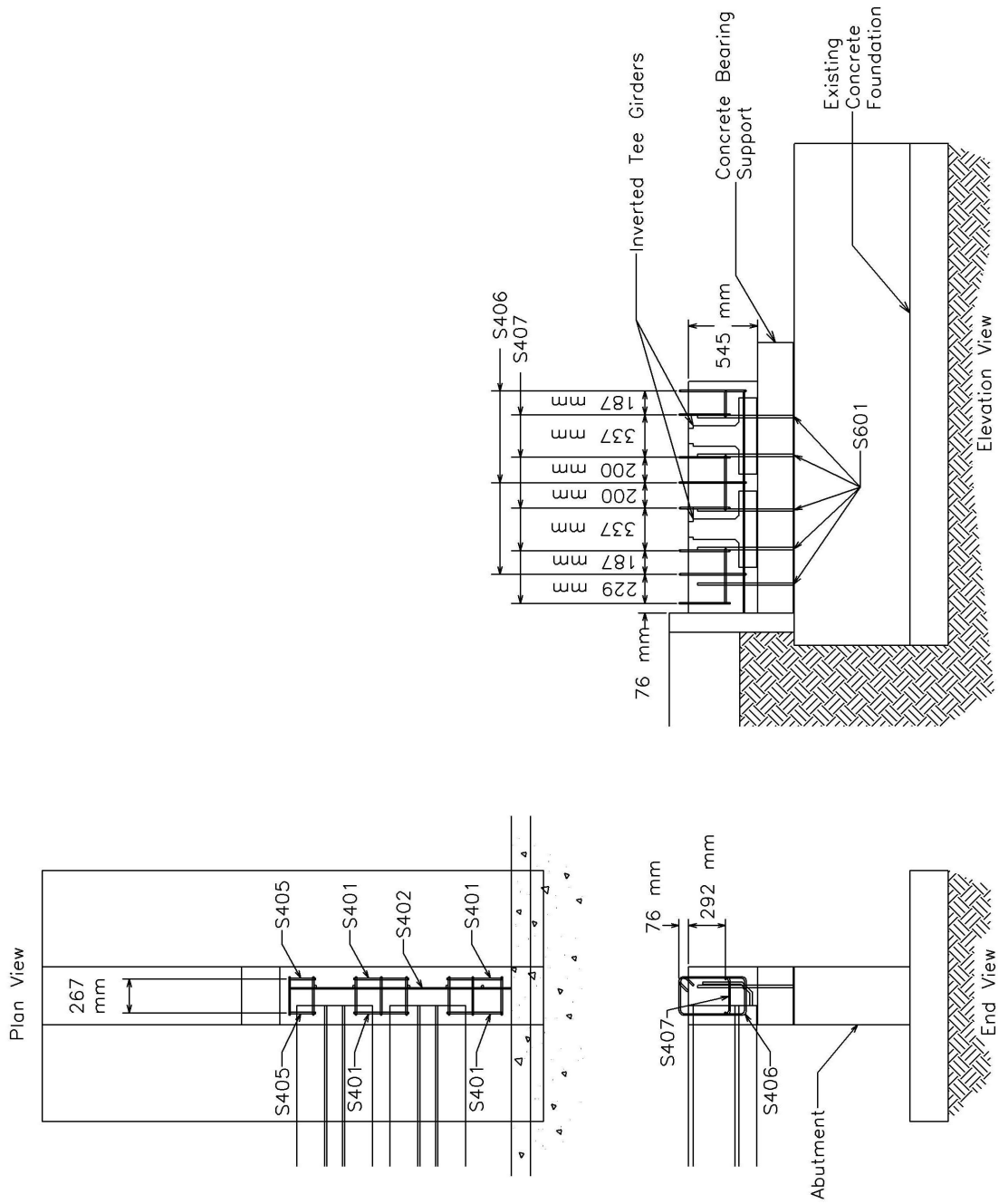

Figure 5. Abutment Joint Details

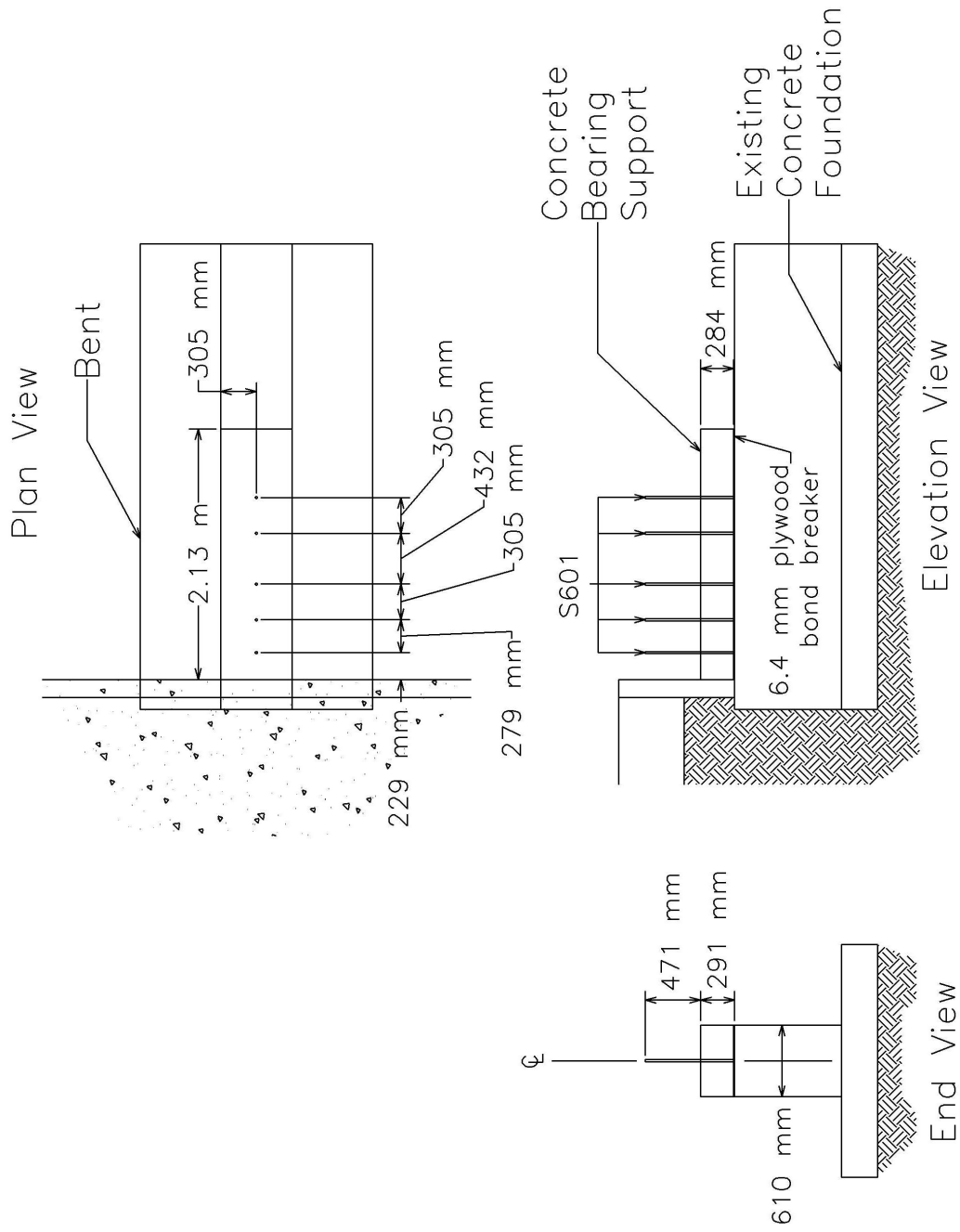

Figure 6. Bent Details

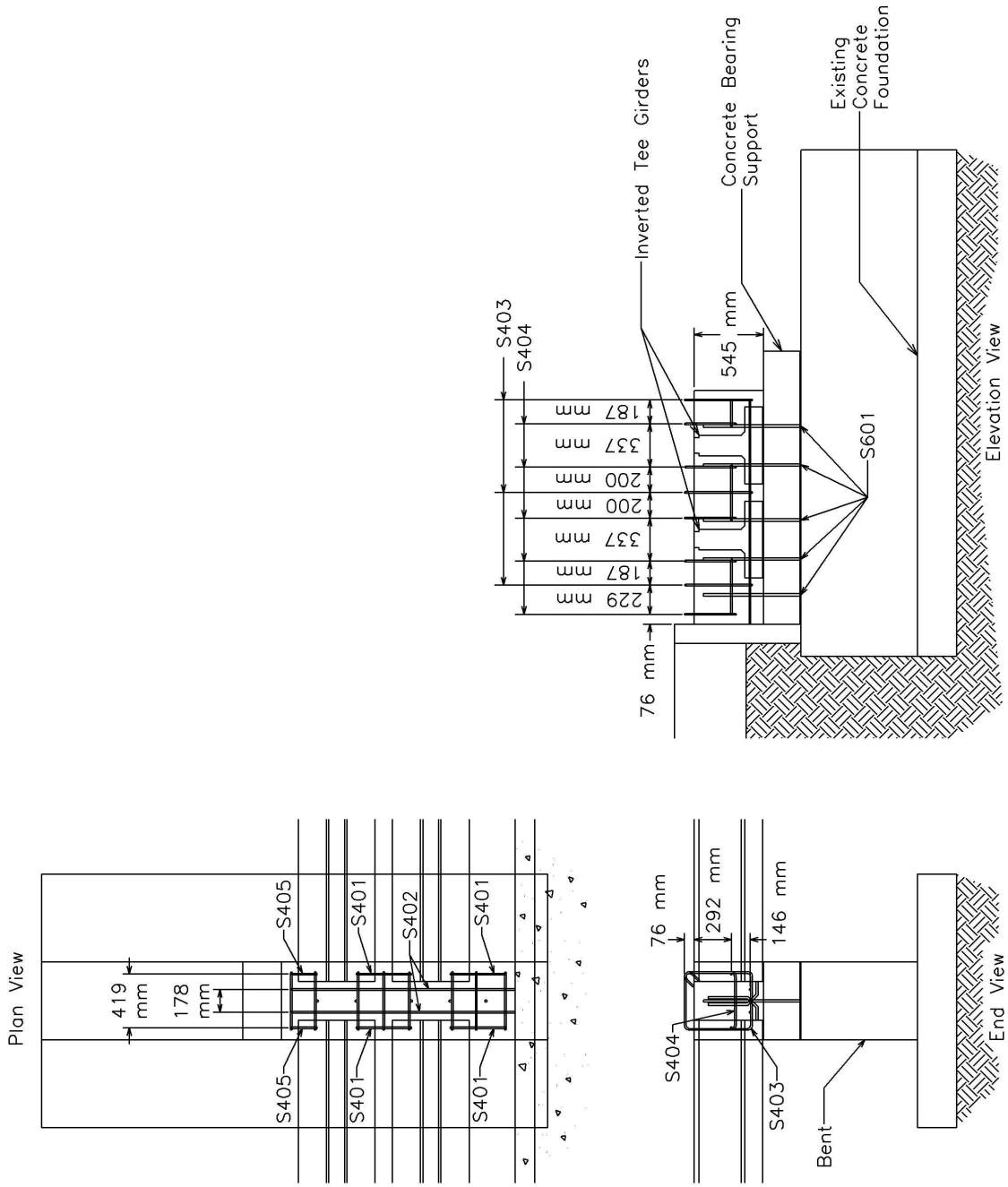

Figure 7. Bent Joint Details

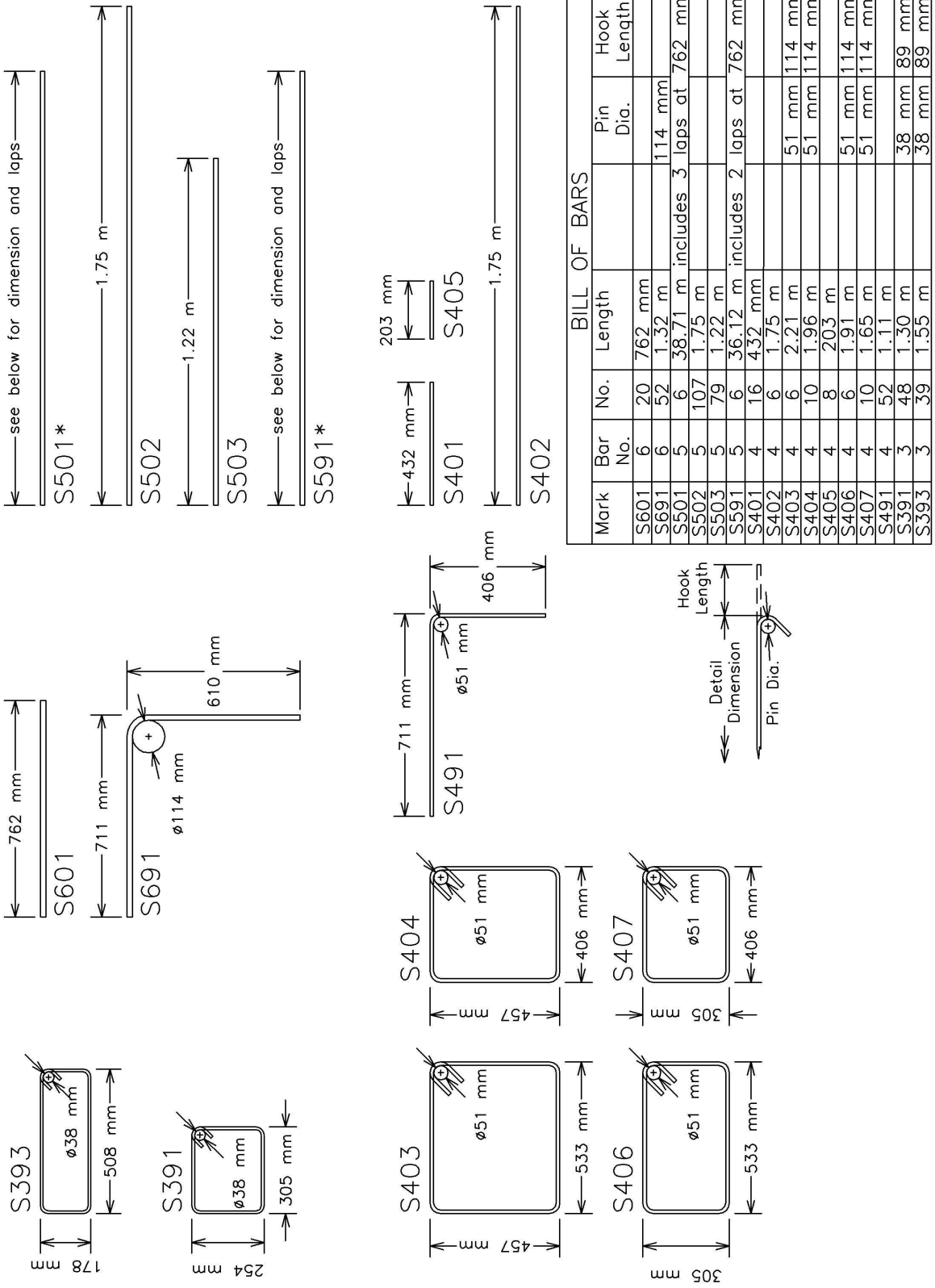

Figure 8. OCR Bridge Rail on Inverted Tee Bridge Deck Bill of Bars



Figure 9. Concrete Girders



Figure 10. Lateral Stiffener End Caps at Upstream and Downstream Abutment Joints



Figure 11. Lateral Stiffener End Caps at Bent Joints



Figure 12. Bridge Deck



Figure 13. Open Concrete Bridge Rail



Figure 14. Open Concrete Bridge Rail

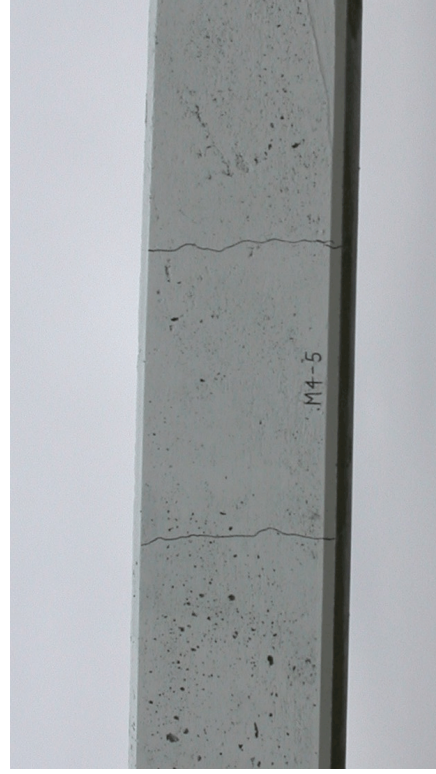

Figure 15. Bridge Rail and Posts

5 TEST CONDITIONS

5.1 Test Facility

The testing facility is located at the Lincoln Air-Park on the northwest (NW) side of the Lincoln Municipal Airport and is approximately 8.0 km (5 mi.) NW of the University of Nebraska-Lincoln.

5.2 Vehicle Tow and Guidance System

A reverse cable tow system with a 1:2 mechanical advantage was used to propel the test vehicle. The distance traveled and the speed of the tow vehicle were one-half that of the test vehicle. The test vehicle was released from the tow cable before impact with the bridge rail system. A digital speedometer was located on the tow vehicle to increase the accuracy of the test vehicle impact speed.

A vehicle guidance system developed by Hinch (8) was used to steer the test vehicle. A guide-flag, attached to the front-right wheel and the guide cable, was sheared off before impact with the bridge rail system. The 9.5-mm (0.375-in.) diameter guide cable was tensioned to approximately 13.3 kN (3,000 lbf), and supported laterally and vertically every 30.48 m (100 ft) by hinged stanchions. The hinged stanchions stood upright while holding up the guide cable, but as the vehicle was towed down the line, the guide-flag struck and knocked each stanchion to the ground. For test NIT-1, the vehicle guidance system was approximately 305-m (1000-ft) long.

5.3 Test Vehicles

For test NIT-1, a 1995 GMC 2500 ¾-ton pickup truck was used as the test vehicle. The test inertial and gross static weights were 2,016 kg (4,445 lbs). The test vehicle is shown in Figure 16, and vehicle dimensions are shown in Figure 17.



Figure 16. Test Vehicle, Test NIT-1

Date: 3/20/02 Test Number: NIT-1 Model: 2000P
 Make: GMC Vehicle I.D.#: 1GDGC24K4SE500791
 Tire Size: 245/75 R16 Year: 1995 Odometer: 246437

*(All Measurements Refer to Impacting Side)

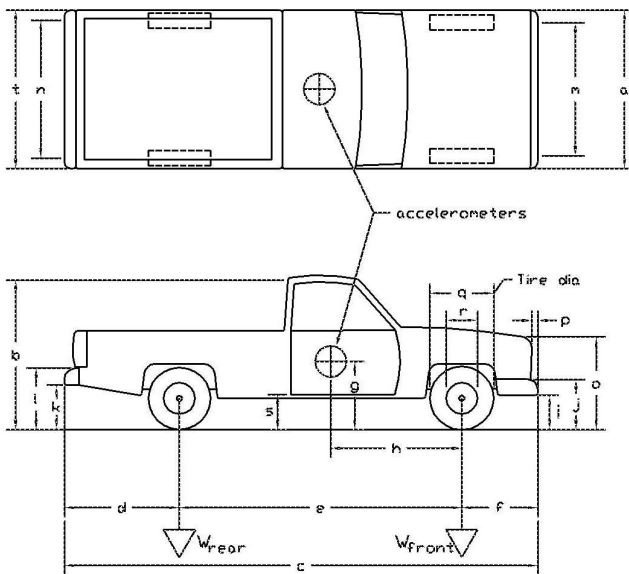

Vehicle Geometry -- mm (in.)

a 1880 (74.0) b 1873 (73.75)
 c 5537 (218.0) d 1327 (53.25)
 e 3346 (131.75) f 864 (34.0)
 g 667 (26.25) h 1375 (54.125)
 i 438 (17.25) j 654 (25.75)
 k 610 (24.0) l 800 (31.5)
 m 1597 (62.875) n 1622 (63.875)
 o 1032 (40.625) p 86 (3.375)
 q 762 (30.0) r 445 (17.5)
 s 495 (19.5) t 1854 (73.0)
 Wheel Center Height Front 371 (14.625)
 Wheel Center Height Rear 371 (14.625)
 Wheel Well Clearance (FR) 908 (35.75)
 Wheel Well Clearance (RR) 959 (37.75)

Weights			
kg (lbs)	Curb	Test Inertial	Gross Static
W_{front}	<u>1135 (2502)</u>	<u>1194 (2633)</u>	<u>1194 (2633)</u>
W_{rear}	<u>828 (1825)</u>	<u>822 (1812)</u>	<u>822 (1812)</u>
W_{total}	<u>1963 (4327)</u>	<u>2016 (4445)</u>	<u>2016 (4445)</u>

Engine Type 8 CYL. GAS
 Engine Size 5.7 L 350 CID
 Transmission Type:
 Automatic or Manual
 FWD or RWD or 4WD

Note any damage prior to test: NONE

Figure 17. Vehicle Dimensions, Test NIT-1

The longitudinal component of the center of gravity was determined using the measured axle weights. The location of the final centers of gravity are shown in Figures 16 and 17.

Square black and white-checked targets were placed on the vehicle to aid in the analysis of the high-speed film and E/cam video, as shown in Figure 18. Round, checkered targets were placed on the center of gravity, on the driver's side door, on the passenger's side door, and on the roof of the vehicle. The remaining targets were located for reference so that they could be viewed from the high-speed cameras for film analysis.

The front wheels of the test vehicle were aligned for camber, caster, and toe-in values of zero so that the vehicle would track properly along the guide cable. Two 5B flash bulbs were mounted on both the hood and roof of the vehicle to pinpoint the time of impact with the bridge rail on the high-speed film and E/cam video. The flash bulbs were fired by a pressure tape switch mounted on the front face of the bumper. A remote-controlled brake system was installed in the test vehicle so the vehicle could be brought safely to a stop after the test.

5.4 Data Acquisition Systems

5.4.1 Accelerometers

One triaxial piezoresistive accelerometer system with a range of ± 200 G's was used to measure the acceleration in the longitudinal, lateral, and vertical directions at a sample rate of 10,000 Hz. The environmental shock and vibration sensor/recorder system, Model EDR-4M6, was developed by Instrumented Sensor Technology (IST) of Okemos, Michigan and includes three differential channels as well as three single-ended channels. The EDR-4 was configured with 6 Mb of RAM memory and a 1,500 Hz lowpass filter. Computer software, "DynaMax 1 (DM-1)" and "DADiSP", was used to analyze and plot the accelerometer data.

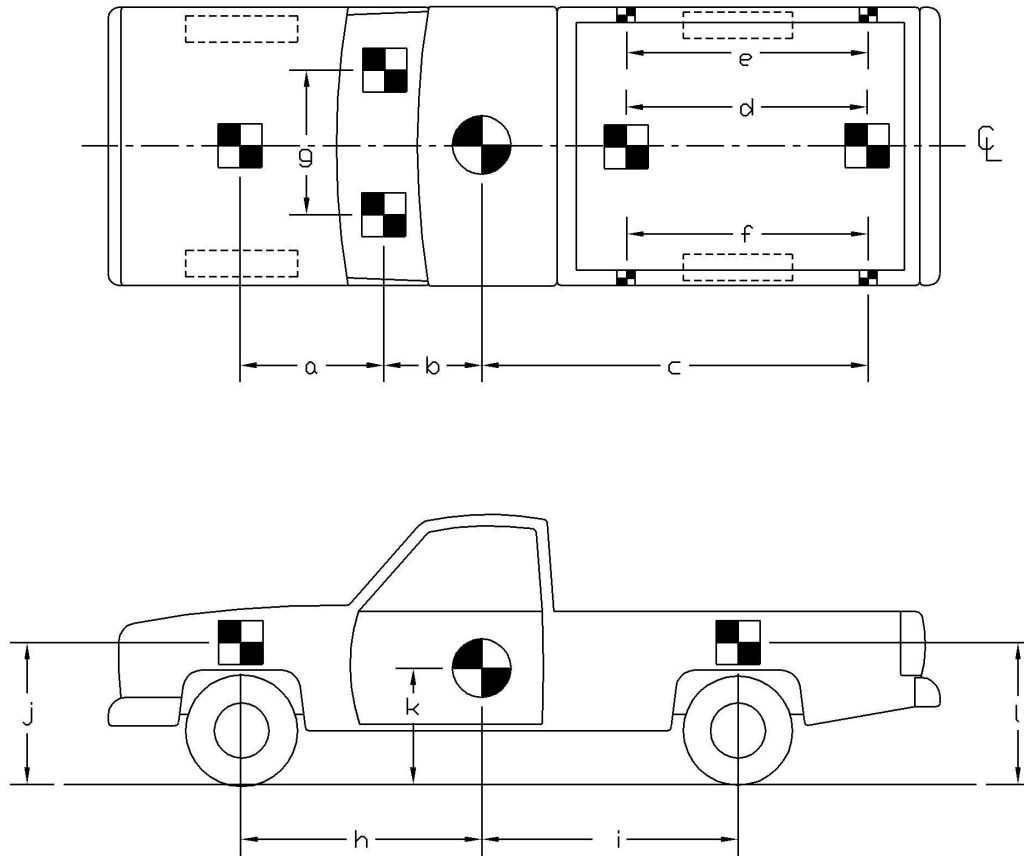

TEST #: <u>NIT-1</u>			
TARGET GEOMETRY -- mm (in.)			
a	<u>918 (36.125)</u>	d	<u>1981 (78.0)</u>
b	<u>724 (28.5)</u>	e	<u>2153 (84.75)</u>
c	<u>2870 (113.0)</u>	f	<u>2153 (84.75)</u>
g	<u>1105 (43.5)</u>	h	<u>1375 (54.125)</u>
j	<u>1010 (34.75)</u>	i	<u>1965 (77.375)</u>
k	<u>667 (26.25)</u>	l	<u>1054 (42.0)</u>

Figure 18. Vehicle Target Locations, Test NIT-1

A backup triaxial piezoresistive accelerometer system with a range of ± 200 G's was also used to measure the acceleration in the longitudinal, lateral, and vertical directions at a sample rate of 3,200 Hz. The environmental shock and vibration sensor/recorder system, Model EDR-3, was developed by Instrumental Sensor Technology (IST) of Okemos, Michigan. The EDR-3 was configured with 256 Kb of RAM memory and a 1,120 Hz lowpass filter. Computer software, "DynaMax 1 (DM-1)" and "DADiSP", was used to analyze and plot the accelerometer data.

5.4.2 Rate Transducers

A Humphrey 3-axis rate transducer with a range of 360 deg/sec in each of the three directions (pitch, roll, and yaw) was used to measure the rates of motion of the test vehicle. The rate transducer was rigidly attached to the vehicle near the center of gravity of the test vehicle. Rate transducer signals, excited by a 28-volt DC power source, were received through the three single-ended channels located externally on the EDR-4M6 and stored in the internal memory. The raw data measurements were then downloaded for analysis and plotted. Computer software, "DynaMax 1 (DM-1)" and "DADiSP", was used to analyze and plot the rate transducer data.

5.4.3 High-Speed Photography

For test NIT-1, two high-speed 16-mm Red Lake Locam cameras, with operating speeds of approximately 500 frames/sec, were used to film the crash test. One Photron high-speed video camera and four high-speed Red Lake E/cam video cameras, all with operating speeds of 500 frames/sec, were also used to film the crash test. Five Canon digital video cameras, with a standard operating speed of 29.97 frames/sec, were also used to film the crash test. A Locam, with a wide-angle 12.5-mm lens, a high-speed Photron video camera, and two high-speed E/cam video cameras were placed above the test installation to provide a field of view perpendicular to the ground. A

Locam, a Canon digital video camera, and a Nikon 995 digital camera were placed downstream from the impact point and had a field of view parallel to the barrier. A Canon digital video camera was placed downstream from the impact point and behind the barrier. A high-speed E/cam video camera and a Canon digital video camera were placed upstream from the impact point and had a field of view parallel to the barrier. A high-speed E/cam video camera and a Canon digital video camera were placed upstream from the point of impact and behind the barrier. A Canon digital video camera, with a panning view, and a Nikon 995 digital camera were placed on the traffic side of the barrier and had a field of view perpendicular to the barrier. A schematic of all fourteen camera locations for test NIT-1 is shown in Figure 19. The Locam films and E/cam videos were analyzed using the Vanguard Motion Analyzer and the Redlake Motion Scope software, respectively. Actual camera speed and camera divergence factors were considered in the analysis of the high-speed film.

5.4.4 Pressure Tape Switches

For test NIT-1, five pressure-activated tape switches, spaced at 2-m (6.56-ft) intervals, were used to determine the speed of the vehicle before impact. Each tape switch fired a strobe light which sent an electronic timing signal to the data acquisition system as the right-front tire of the test vehicle passed over it. Test vehicle speed was determined from electronic timing mark data recorded using the "Test Point" software. Strobe lights and high-speed film analysis are used only as a backup in the event that vehicle speed cannot be determined from the electronic data.

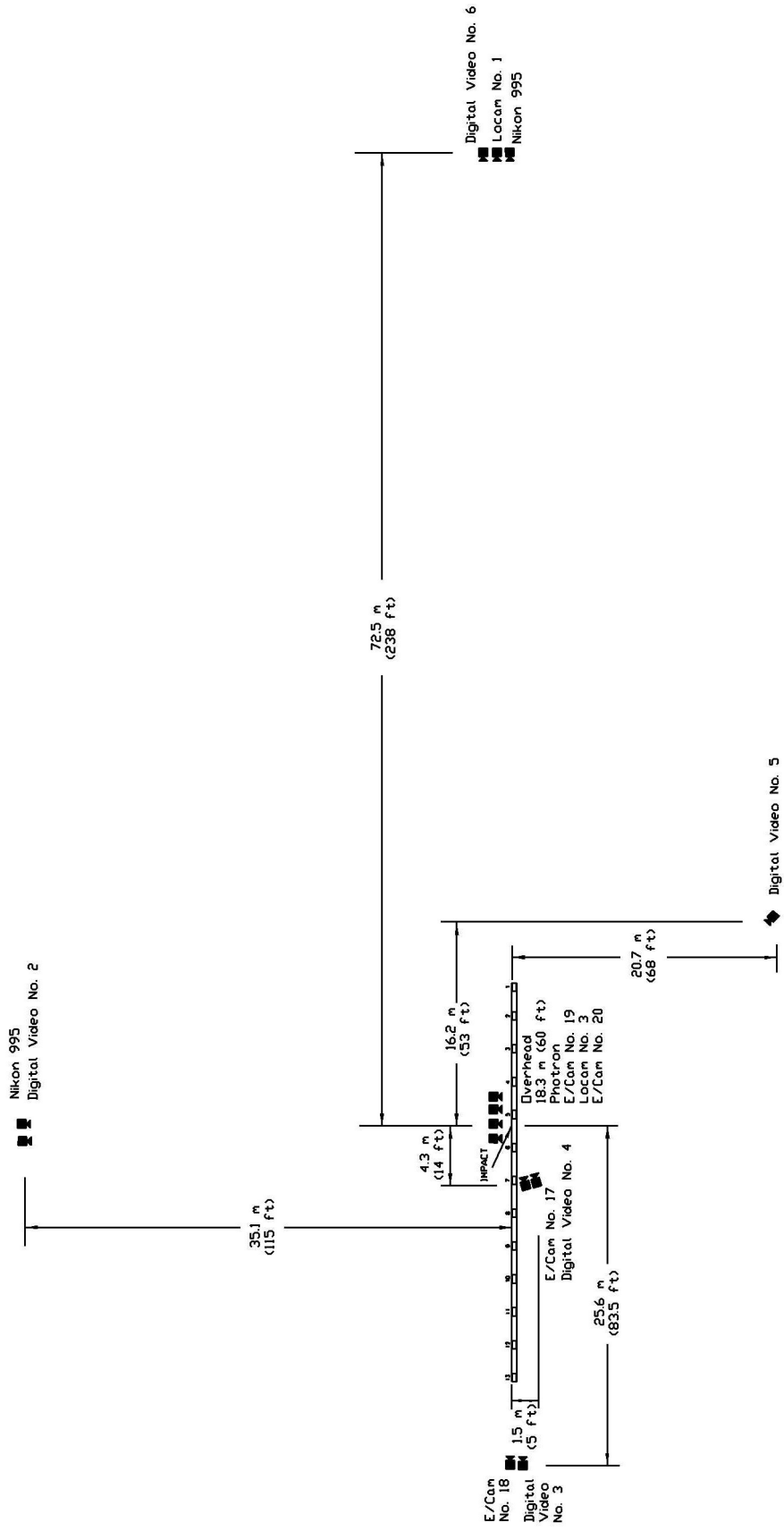

Figure 19. Location of High-Speed Cameras, Test NIT-1

6 CRASH TEST NO. 1

6.1 Test NIT-1

The 2,016-kg (4,445-lb) pickup truck impacted the open concrete bridge rail at a speed of 99.8 km/hr (62.0 mph) and at an angle of 26.6 degrees. A summary of the test results and the sequential photographs are shown in Figure 20. The summary of the test results and sequential photographs in English units is shown in Appendix B. Additional sequential photographs are shown in Figures 21 and 22. Documentary photographs of the crash test are shown in Figures 23 through 26.

6.2 Test Description

Initial impact occurred between bridge post nos. 5 and 6 or 10.56 m (34 ft-8 in.) downstream from the upstream end of the system, as shown in Figure 27. At 0.020 sec after impact, the front bumper shifted toward the left side of the vehicle as the right side crushed inward. Shortly after this time, minor dynamic rail deflections occurred. At 0.034 sec, the right-front tire contacted the bridge rail and began to rotate parallel to the rail. At 0.047 sec, the right-front corner of the vehicle protruded over the top of the rail. At this same time, the bumper continued to deform inward. At 0.079 sec, the truck began to redirect as the top of the right-side door became ajar. At 0.08 sec, the right-front corner of the vehicle reached its maximum intrusion of 587 mm (23 in.) over the rail. At 0.096 sec, the area between the vehicle's cab and box began to rise into the air. At 0.121 sec, the left-front tire became airborne. At 0.126 sec, the entire right-side of the vehicle's cab was in contact with the rail. At 0.167 sec, the left-rear tire became airborne. At 0.192 sec, the right-rear corner of the vehicle contacted the rail. The vehicle became parallel to the bridge rail at 0.221 sec after impact with a resultant velocity of 79.6 km/hr (49.4 mph). At this same time, the vehicle began to roll

clockwise (CW) toward the rail with the box above the rail. At 0.236 sec, the bottom of the box contacted the top of the rail. At 0.308 sec, the cab of the vehicle was no longer in contact with the rail. At this same time, the left rear of the vehicle began to rise into the air with both left tires still airborne. At 0.388 sec, the right-rear corner of the vehicle was in contact with the top of the rail as the vehicle rolled approximately 25 degrees CW toward the rail. At 0.451 sec, the right-front corner of the vehicle pitched downward. At 0.535 sec, the right-front corner pitched downward to the point of almost being in contact with the ground as the vehicle rolled 30 degrees toward the rail. At 0.592 sec, the vehicle exited the bridge rail at an estimated trajectory angle of 13 to 15 degrees and at a resultant velocity of 80.0 km/hr (49.7 mph). At this same time, the right-rear tires were airborne as the box of the vehicle rolled approximately 45 degrees toward the rail. At 0.835 sec, the vehicle began to roll counter-clockwise (CCW) away from the rail after reaching its maximum roll angle of 30 degrees. By 1.217 sec, all tires had contacted the ground with the right-rear tire contacting first followed by the left-front tire and then the left-rear tire. At 1.287 sec, the right-rear tire disengaged from the vehicle. The vehicle came to rest 48.16 m (158 ft) downstream from impact and 1.52 m (5 ft) laterally behind a line projected parallel to the traffic-side face of the bridge rail, as shown in Figures 20 and 28.

6.3 Barrier Damage

Damage to the barrier was moderate, as shown in Figures 29 through 36. Barrier damage consisted of deck, post, and rail cracking along with contact and gouge marks. The length of vehicle contact along the concrete bridge rail was approximately 4 m (13 ft).

The damage to the front of the posts and rail consisted of a very fine diagonal crack above post no. 4 and a crack at the base of post no. 4. Vertical cracks were found on the rail just

downstream of post no. 4 and on the upstream and downstream sides of post no. 5. Light cracks were found on the front, upstream, and downstream faces of post no. 5. Heavy cracks were also found on post no. 6 and on the top of the rail between post nos. 5 and 7. Hairline cracks were found on the backside faces of post nos. 5 and 6. Concrete spalling, 25-mm (1-in.) deep by 76-mm (3-in.) wide by 381-mm (15-in.) long, was found slightly upstream of post no. 6. Black contact marks were found on the rail 686-mm (27-in.) downstream from the center of post no. 5 through 178-mm (7-in.) upstream from the center of post no. 7.

Damage to the deck consisted of minor hairline cracks and black contact marks. One crack originated at the front-upstream corner of post no. 5 and continued diagonally back 559 mm (22 in.) then down the back of the deck for 203 mm (8 in.) for a total length of 762 mm (30 in.) upstream from the upstream face of post no. 5. Another crack originated at the downstream face of post no. 5, continued diagonally for about 254 mm (10 in.) where it reached the back edge of the deck and then continued for 152 mm (6 in.) diagonally along the back face of the deck. A third crack originated at the upstream face of post no. 6 and continued diagonally upstream for 279 mm (11 in.) then 178 mm (7 in.) diagonally along the back face of the deck. Another crack originated at the back face of post no. 6 and propagated diagonally downstream 305 mm (12 in.) and then 305 mm (12 in.) along the back face of the deck. A final crack originated at the back face of post no. 6 and continued 610 mm (24 in.) diagonally downstream and then 305 mm (12 in.) diagonally across the back face of the deck. Black tire contact marks, measuring 229-mm (9-in.) wide by 2.24-m (88-in.) long, were found on the concrete deck in front of post no. 6.

The bridge rail did not encounter any permanent set deflections, and only minor dynamic deflections were observed. The maximum dynamic lateral deflection, as determined from high-speed film analysis, was 22 mm (0.9 in.) at 1,219 mm (48 in.) upstream of impact.

6.4 Vehicle Damage

Exterior vehicle damage was moderate, as shown in Figures 37 through 41. Moderate occupant compartment deformations occurred with deformations to the right-side floor pan and firewall, as shown in Figure 41. Occupant compartment deformations and the corresponding locations are provided in Appendix C.

Damage was concentrated on the right-front corner and right side of the vehicle. The right-front corner of the vehicle was crushed inward and back, including the fender, bumper, and frame rail. A buckling point was found at the center of the front bumper. A major crease was found in the frame just behind the right-front control arm. The right-front upper control arm and tie-rod disengaged completely. The right-front lower control arm joint was fractured and still attached. The right-front brake line was severed, and the exhaust manifold was cracked above the control arm assembly. Scuff marks were found on the right-rear wheel well, and the tire was ripped away from the hub rivets. The back of the right-front steel rim was damaged from the lower control arm, and the tire was separated from the rim. Deformation of the right-side door and the right side of the truck bed were also observed, and heavy contact marks were found along the entire right side of the vehicle. The top of the right-side door and the hood were jarred open. The grill was broken and deformed around the right-side headlight assembly. The right side of the radiator housing was deformed. The truck's cab shifted toward the left approximately 51 mm (2 in.) offset from the truck box. A small crease was observed on the left-front fender. The lower-right corner of the windshield encountered a minor crack and starrng. The left-rear tire remained inflated. The roof and the right-side, left-side, and rear window glass remained undamaged.

6.5 Occupant Risk Values

The longitudinal and lateral occupant impact velocities were determined to be 6.60 m/sec (21.65 ft/sec) and 7.52 m/sec (25.43 ft/sec), respectively. The maximum 0.010-sec average occupant ridedown decelerations in the longitudinal and lateral directions were 6.29 g's and 7.75 g's, respectively. It is noted that the occupant impact velocities (OIV's) and occupant ridedown decelerations (ORD's) were within the suggested limits provided in NCHRP Report No. 350. The results of the occupant risk, determined from the accelerometer data, are summarized in Figure 20. Results are shown graphically in Appendix D. Roll and yaw data were collected from film analysis and are shown graphically in Appendix E.

6.6 Discussion

The analysis of the test results for test NIT-1 showed that the open concrete bridge rail attached to an inverted tee bridge deck system adequately contained and redirected the vehicle with controlled lateral displacements of the bridge rail. There were no detached elements nor fragments which showed potential for penetrating the occupant compartment or presented undue hazard to other traffic. Deformations of, or intrusion into, the occupant compartment that could have caused serious injury did not occur. The test vehicle did not penetrate nor ride over the bridge rail and remained upright during and after the collision. Vehicle roll, pitch, and yaw angular displacements were noted, but they were deemed acceptable because they did not adversely influence occupant risk safety criteria nor cause rollover. After collision, the vehicle's trajectory revealed minimum intrusion into adjacent traffic lanes. In addition, the vehicle's exit angle was less than 60 percent of the impact angle. Therefore, test NIT-1 conducted on the open bridge rail attached to an inverted tee bridge deck system was determined to be acceptable according to the TL-4 safety performance criteria found in NCHRP Report No. 350.

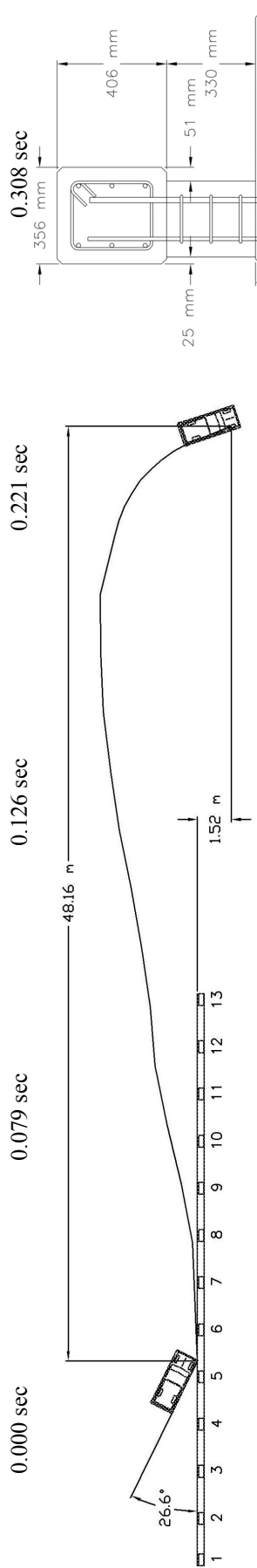
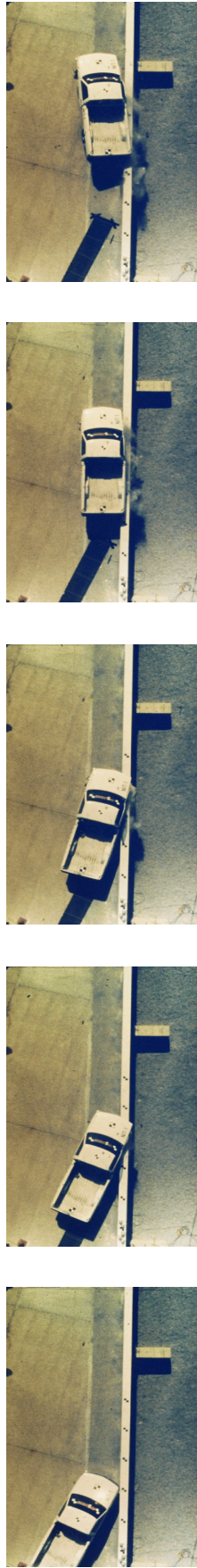

● Test Number	NIT-1	● Vehicle Speed	99.8 km/hr
● Date	3/20/02	● Impact	80.0 km/hr
● Appurtenance	Nebraska's Open Concrete Bridge Rail Attached to an Inverted Tee Bridge Deck System	● Vehicle Angle	26.6 deg
● Total Length	31.95 m	● Impact	est. 13-15 deg
● Concrete Material	Nebraska 47-BD Mix	● Exit	None
● Reinforcing Steel Material	Grade 60 Rebar - Epoxy Coated	● Vehicle Snagging	None
● Concrete Bridge Rail		● Vehicle Pocketing	None
Length	29.57 m	● Vehicle Stability	Satisfactory
Width	356 mm	● Occupant Ridedown Deceleration (10 msec avg.)	6.29 G's < 20 G's
Depth	406 mm	Longitudinal	7.75 G's
Top Mounting Height	737 mm	Lateral (not required)	
● Concrete Bridge Posts		● Occupant Impact Velocity	6.60 m/s < 12 m/s
Length	610 mm	Longitudinal	7.75 m/s
Width	279 mm	● Lateral (not required)	Moderate
Height	330 mm	● Vehicle Damage	I-RFQ-4
Spacing	2,438 mm	TAD ⁹	I-RFEW4
● Concrete Bridge Deck		SAE ¹⁰	48.16 m downstream
Length	31.95 m	● Vehicle Stopping Distance	1.52 m laterally behind
Width	1,829 mm	● Barrier Damage	Moderate
Thickness	152 mm	● Maximum Rail Deflections	NA
● Vehicle Model	1995 GMC 2500 ¾-ton pickup	Permanent Set	22 mm
Curb	1,963 kg	Dynamic	587 mm
Test Inertial	2,016 kg	● Working Width	
Gross Static	2,016 kg		

Figure 20. Summary of Test Results and Sequential Photographs, Test NIT-1



0.000 sec



0.062 sec



0.144 sec



0.236 sec



0.434 sec



0.810 sec



0.000 sec



0.100 sec



0.200 sec



0.334 sec



0.701 sec



3.370 sec

Figure 21. Additional Sequential Photographs, Test NIT-1



0.000 sec



0.000 sec



0.167 sec



0.067 sec



0.300 sec



0.167 sec



0.534 sec



0.300 sec



0.701 sec



0.434 sec



1.368 sec

Figure 22. Additional Sequential Photographs, Test NIT-1



Figure 23. Perpendicular Documentary Photographs, Test NIT-1



Figure 24. Downstream Documentary Photographs, Test NIT-1



Figure 25. Downstream Documentary Photographs, Test NIT-1



Figure 26. Downstream Documentary Photographs, Test NIT-1



Figure 27. Impact Location, Test NIT-1



Figure 28. Vehicle Final Position and Trajectory Marks, Test NIT-1



Figure 29. Open Concrete Bridge Rail System Damage, Test NIT-1



Figure 30. Open Concrete Bridge Rail System Damage, Test NIT-1

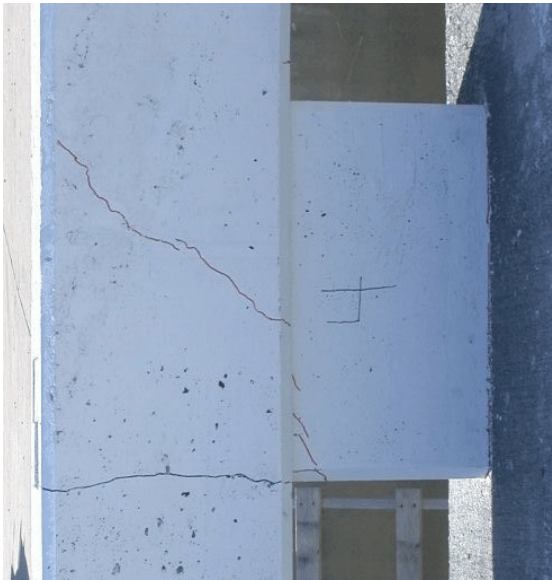
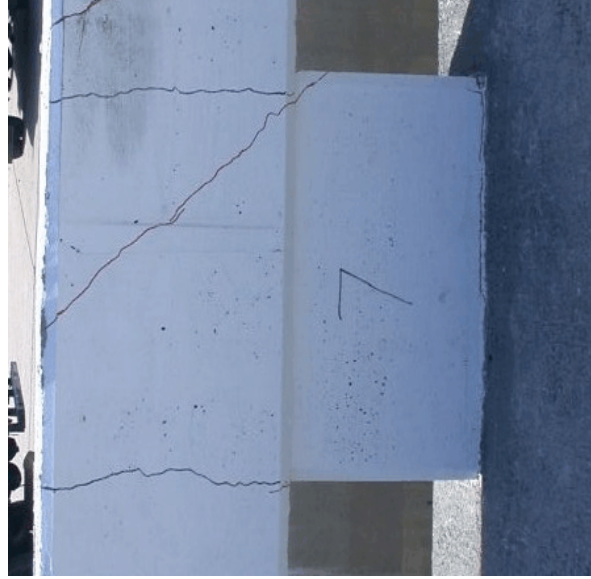

Figure 31. Open Concrete Bridge Rail Post Damage, Test NIT-1

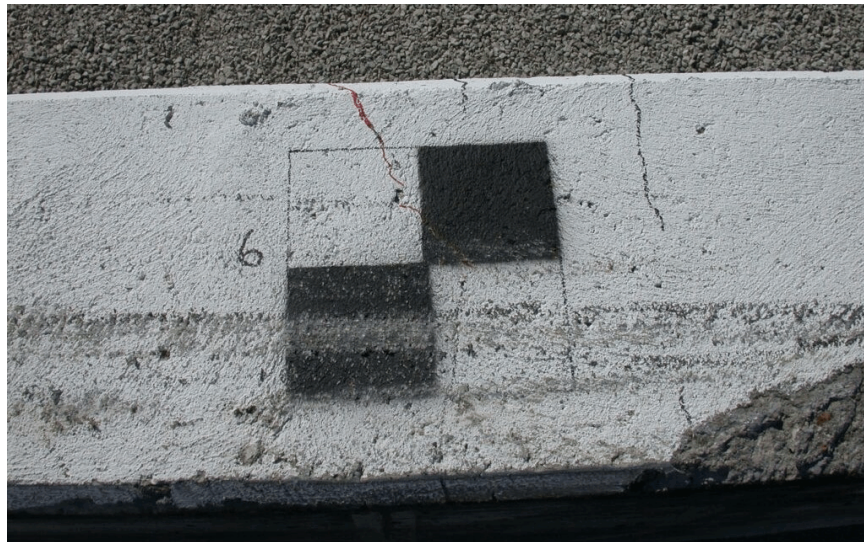
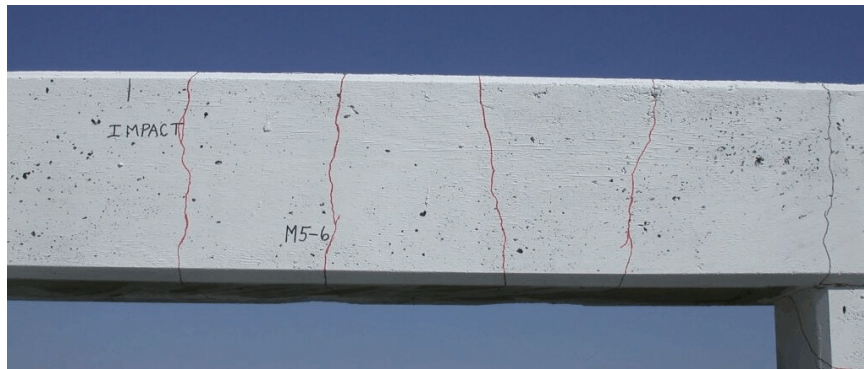

Figure 32. Open Concrete Bridge Rail Damage, Test NIT-1



Figure 33. Open Concrete Bridge Rail Damage, Test NIT-1

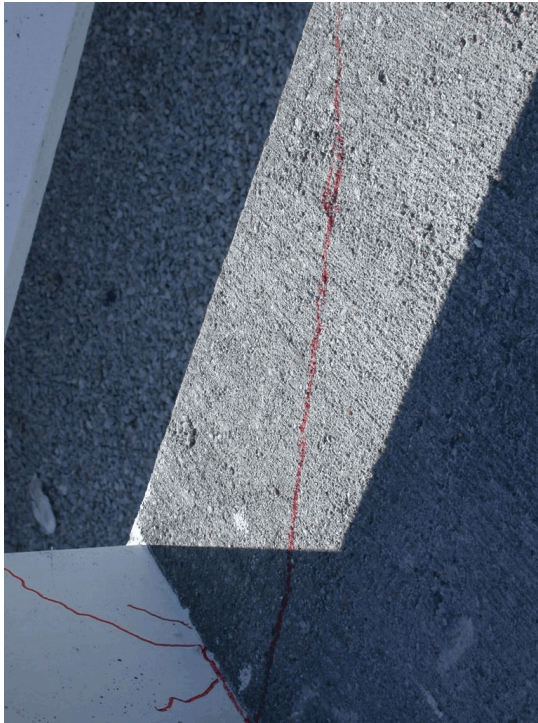

Figure 34. Bridge Deck Damage Around Post No. 5, Test NIT-1



Figure 35. Bridge Deck Damage Around Post No. 6, Test NIT-1

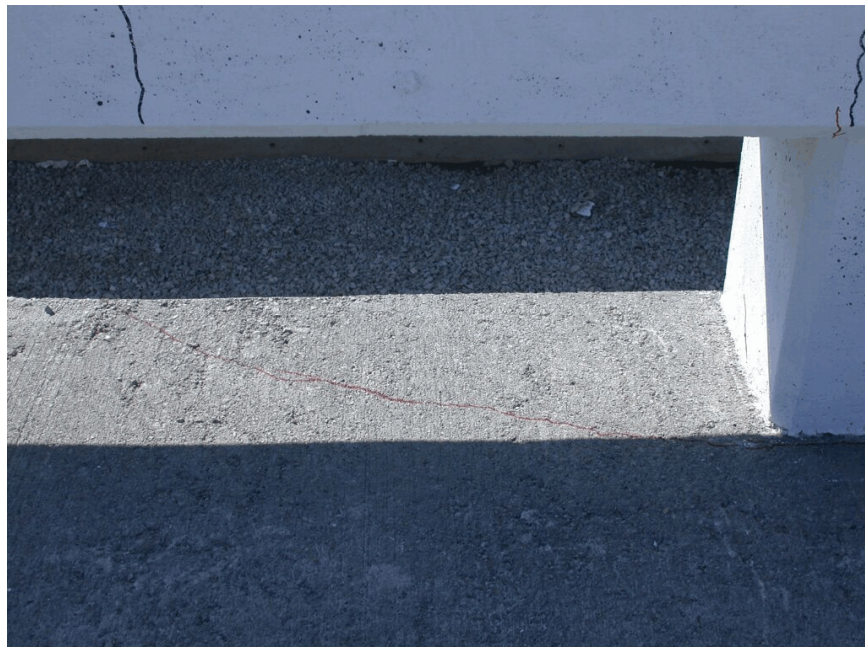

Figure 36. Bridge Deck Damage Around Post No. 7, Test NIT-1



Figure 37. Vehicle Damage, Test NIT-1



Figure 38. Vehicle Damage, Test NIT-1

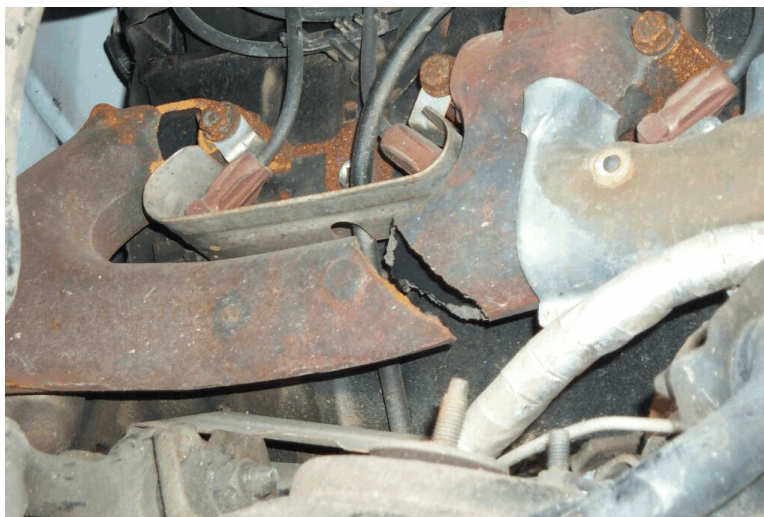

Figure 39. Vehicle Undercarriage Damage, Test NIT-1



Figure 40. Windshield Damage, Test NIT-1



Figure 41. Occupant Compartment Damage, Test NIT-1

7 SUMMARY AND CONCLUSIONS

An open concrete bridge rail attached to an inverted tee bridge deck system was constructed and full-scale vehicle crash tested. A full-scale vehicle crash test was performed with a $\frac{3}{4}$ -ton pickup truck on the bridge rail system and was determined to be acceptable according to the TL-4 safety performance criteria presented in NCHRP Report No. 350. A summary of the safety performance evaluation is provided in Table 3.

Table 3. Summary of Safety Performance Evaluation Results

Evaluation Factors	Evaluation Criteria	Test NIT-1
Structural Adequacy	A. Test article should contain and redirect the vehicle; the vehicle should not penetrate, underride, or override the installation although controlled lateral deflection of the test article is acceptable.	S
Occupant Risk	D. Detached elements, fragments or other debris from the test article should not penetrate or show potential for penetrating the occupant compartment, or present an undue hazard to other traffic, pedestrians, or personnel in a work zone. Deformations of, or intrusions into, the occupant compartment that could cause serious injuries should not be permitted.	S
	F. The vehicle should remain upright during and after collision although moderate roll, pitching, and yawing are acceptable.	S
Vehicle Trajectory	K. After collision it is preferable that the vehicle's trajectory not intrude into adjacent traffic lanes.	S
	L. The occupant impact velocity in the longitudinal direction should not exceed 12 m/sec (39.37 ft/sec), and the occupant ridedown acceleration in the longitudinal direction should not exceed 20 G's.	S
	M. The exit angle from the test article preferably should be less than 60 percent of test impact angle measured at time of vehicle loss of contact with test device.	S

S - Satisfactory
M - Marginal
U - Unsatisfactory
NA - Not Available

8 RECOMMENDATIONS

An open concrete bridge rail attached to an inverted tee bridge deck system, as described in this report, was successfully crash tested according to the criteria found in NCHRP Report No. 350. The results of this test indicate that this design is a suitable design for use on Federal-aid highways. However, any design modifications made to the bridge railing system can only be verified through the use of full-scale crash testing.

The open concrete bridge rail has previously passed the small car NCHRP Report 230 performance criteria without any occupant risk problems arising from the snagging or overturning of the vehicle (5). In addition, the open concrete bridge rail has been certified by FHWA to meet NCHRP Report No. 350 TL-4 through previous successful testing according to the AASHTO PL-2 evaluation criteria (1-2). This system was attached to the bridge deck with vertical reinforcing bars that were tied to two layers of reinforcement in the bridge deck during construction. Both single-unit trucks were smoothly redirected without any tendency to rollover, and the structural adequacy of the rail was maintained and both pickup trucks sustained moderate occupant compartment damage, but the occupant compartment integrity was maintained.

MwRSF researchers believed that the TL-4 pickup truck test conditions impart the maximum dynamic lateral loading into the bridge rail system and therefore should be used to demonstrate the critical deck performance. The pickup test conducted on the bridge rail system attached to an inverted tee bridge deck produced only minor cracks to both the bridge deck, rail, and posts, consequently verifying its performance on thin decks with less reinforcement. Therefore, the open concrete bridge rail attached to an inverted tee bridge deck is recommended for use on the National Highway System as a TL-4 approved barrier system.

9 REFERENCES

1. Holloway, J.C., Faller, R.K., Wolford, D.F., Dye, D.L., and Sicking, D.L., *Performance Level 2 Tests on a 29-in. Open Concrete Bridge Rail*, Final Report to the Midwest States' Regional Pooled Fund Program, Transportation Research Report No. TRP-03-51-95, Project No. SPR-03(017)-Fiscal Year 1994, Midwest Roadside Safety Facility, University of Nebraska-Lincoln, Lincoln, NE, June 1996.
2. Holloway, J.C., Sicking, D.L., and Faller, R.K., *A Reduced Height Performance Level 2 Bridge Rail*, Transportation Research Record No. 1528, Transportation Research Board, National Research Council, Washington, D.C., 1996.
3. *Guide Specifications for Bridge Railings*, American Association of State Highway and Transportation Officials, Washington, D.C., 1989.
4. Ross, H.E., Sicking, D.L., Zimmer, R.A., and Michie, J.D., *Recommended Procedures for the Safety Performance Evaluation of Highway Features*, National Cooperative Research Program (NCHRP) Report No. 350, Transportation Research Board, Washington, D.C., 1993.
5. Stout, D. and Hinch, J., *Test and Evaluation of Traffic Barriers: Final Report - Technical*, Report No. FHWA-RD-89-119, Submitted to the Office of Safety and Traffic Operations R & D, Federal Highway Administration, Performed by ENSCO, Inc., Springfield, VA, April 1989.
6. Michie, J.D., *Recommended Procedures for the Safety Performance Evaluation of Highway Appurtenances*, National Cooperative Highway Research Program (NCHRP) Report No. 230, Transportation Research Board, Washington, D.C., March 1981.
7. Faller, R.K., Holloway, J.C., Pfiefer, B.G., and Rosson, B.T., Final Report to the Nebraska Department of Roads, Transportation Research Report No. TRP-03-28-91, Midwest Roadside Safety Facility, University of Nebraska-Lincoln, Lincoln, NE, February 1992.
8. Hinch, J., Yang, T.L., and Owings, R., *Guidance Systems for Vehicle Testing*, ENSCO, Inc., Springfield, VA, 1986.
9. *Vehicle Damage Scale for Traffic Investigators*, Second Edition, Technical Bulletin No. 1, Traffic Accident Data (TAD) Project, National Safety Council, Chicago, Illinois, 1971.
10. *Collision Deformation Classification - Recommended Practice J224 March 1980*, Handbook Volume 4, Society of Automotive Engineers (SAE), Warrendale, Pennsylvania, 1985.

10 APPENDICES

APPENDIX A

English-Unit System Drawings and Nebraska's Standard Plans

Figure A-1. Layout for Open Concrete Bridge Rail Attached to Inverted Tee Bridge Deck System (English)

Figure A-2. Bridge Rail Profile Details (English)

Figure A-3. Inverted Tee Bridge Deck System Reinforcement Details (English)

Figure A-4. Abutment Details (English)

Figure A-5. Abutment Joint Details (English)

Figure A-6. Bent Details (English)

Figure A-7. Bent Joint Details (English)

Figure A-8. OCR Bridge Rail on Inverted Tee Bridge Deck Bill of Bars (English)

Figure A-9. NDOR's Bridge Deck Standard Plan (English)

Figure A-10. NDOR's Open Concrete Bridge Rail Standard Plans (English)

Figure A-11. NDOR's Inverted Tee Standard Plans (English)

Plan View 1

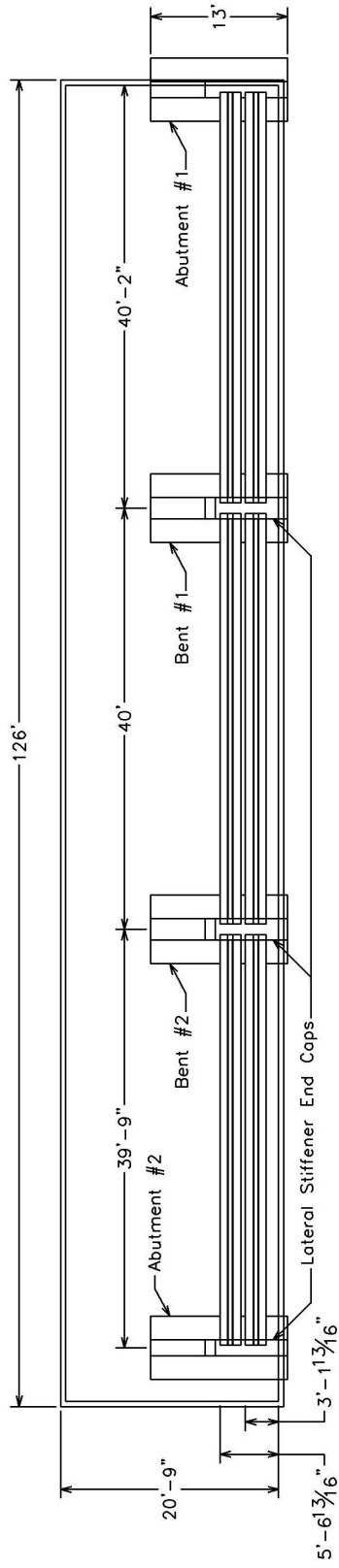

Plan View 2

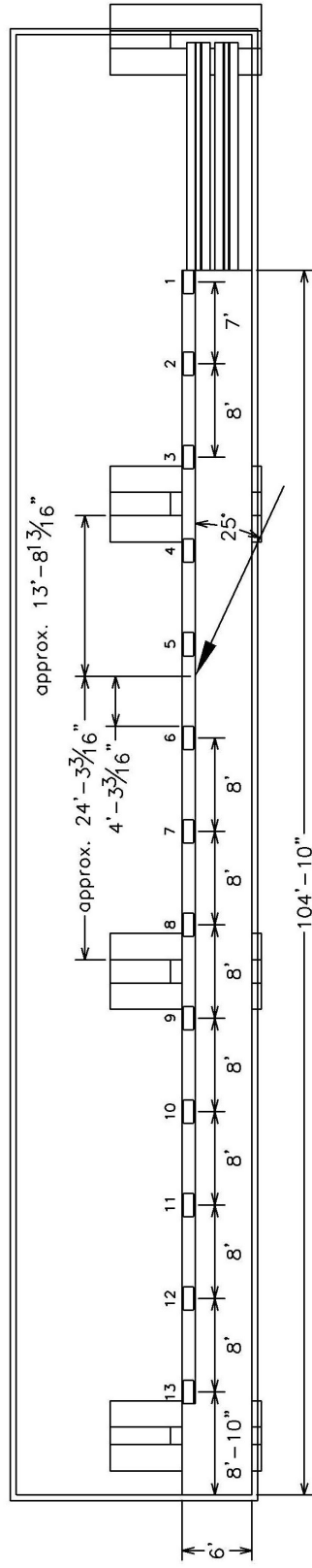
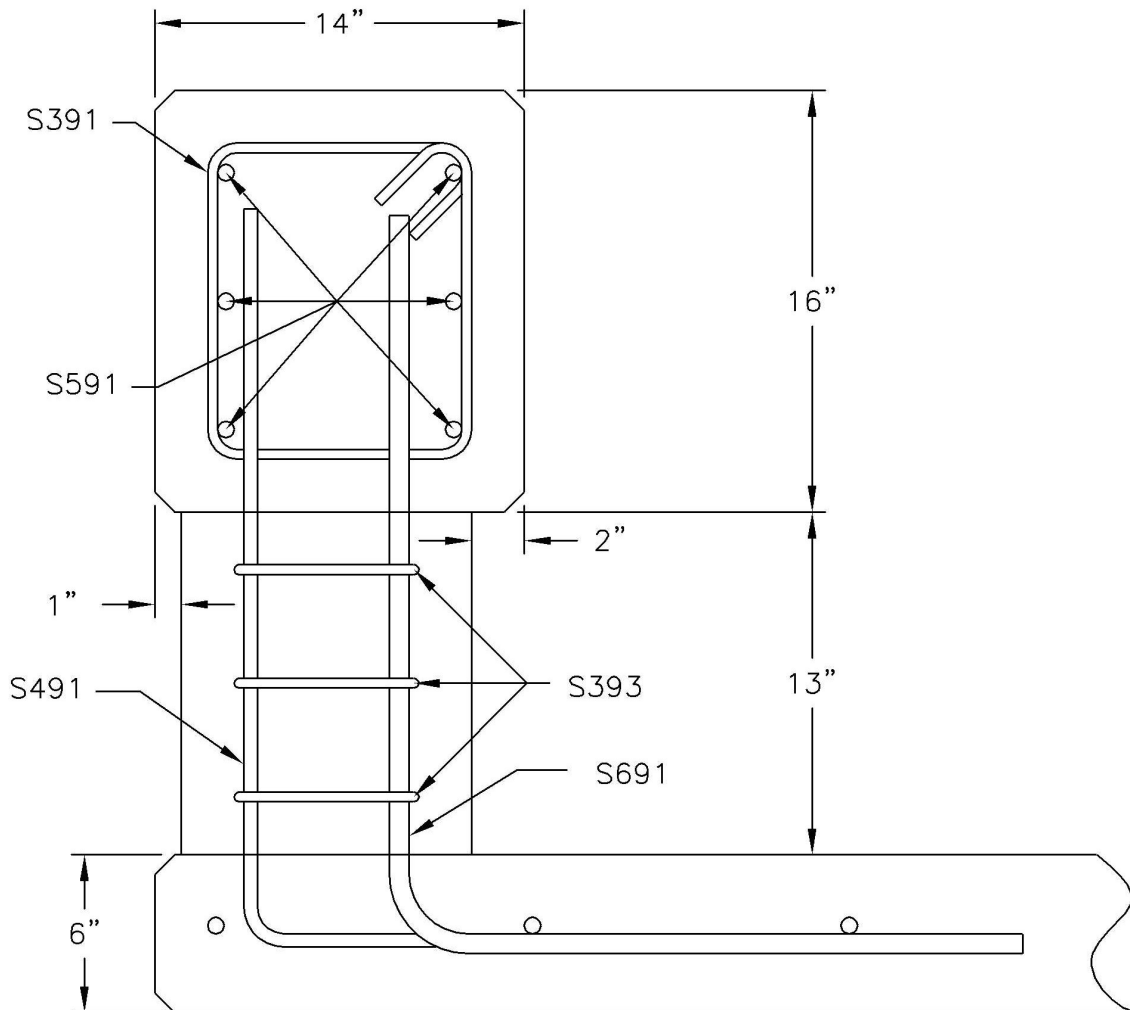

Figure A-1. Layout for Open Concrete Bridge Rail Attached to Inverted Tee Bridge Deck System (English)



NOTES:

- (1) USE GRADE 60 REINFORCING STEEL
- (2) USE NEBRASKA 47-BD TYPE 3 CONCRETE MIX DESIGN WITH 4,500 PSI MINIMUM 28-DAY CONCRETE COMPRESSIVE STRENGTH
- (3) USE 24 IN. MINIMUM BAR LAP FOR ALL LONGITUDINAL AND TRANSVERSE BARS
- (4) USE 2 IN. CONCRETE COVER FOR ALL CONSTRUCTION

Figure A-2. Bridge Rail Profile Details (English)

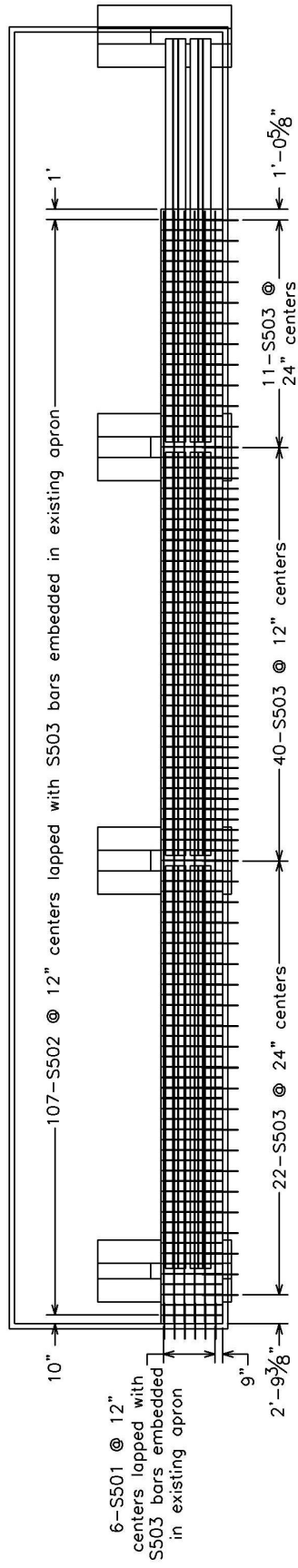

Note:
 1) All S503 bars embedded 24" into existing apron
 2) S503 bars lapped 24" with either S501 or S502 bars

Figure A-3. Inverted Tee Bridge Deck System Reinforcement Details (English)

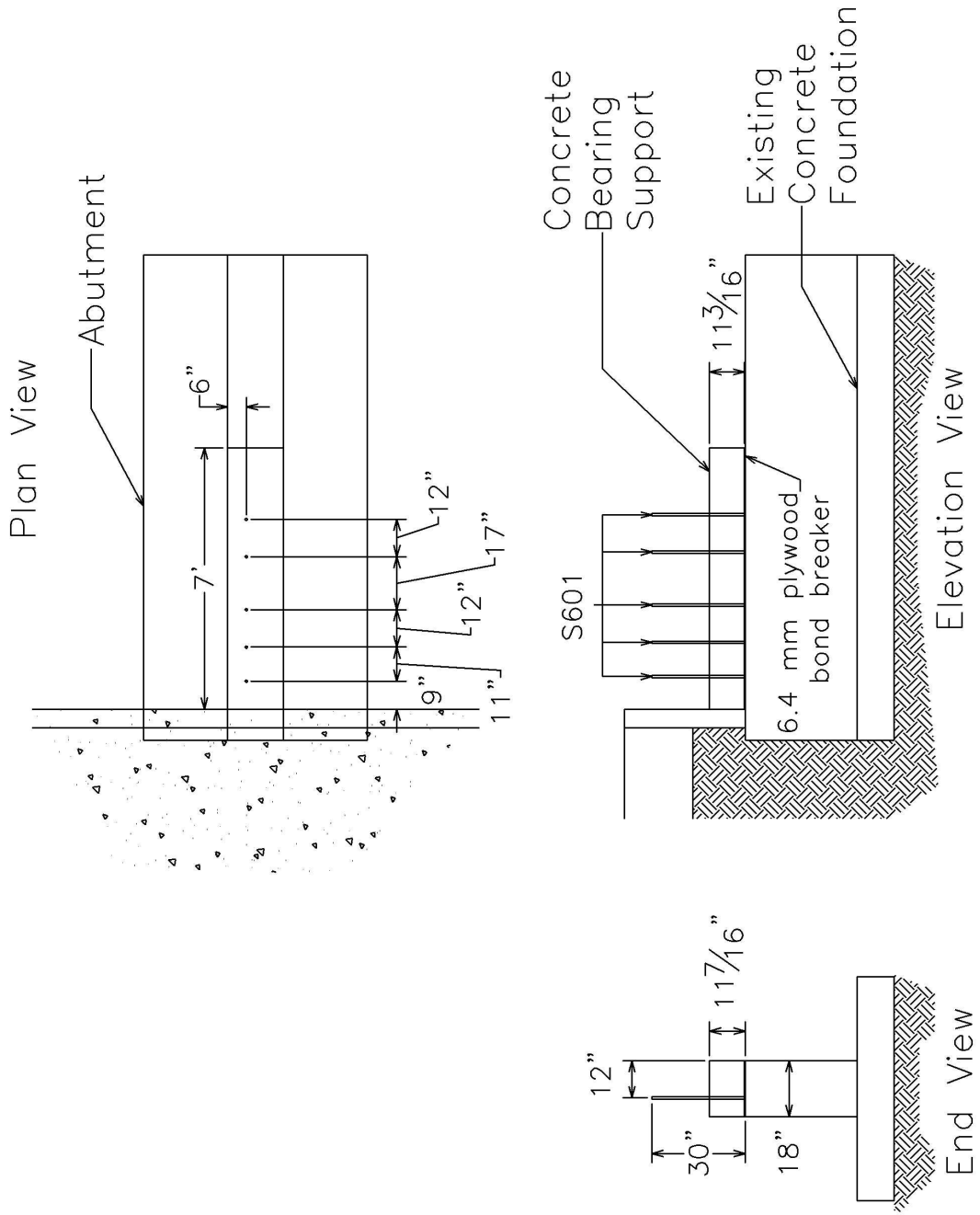

Figure A-4. Abutment Details (English)

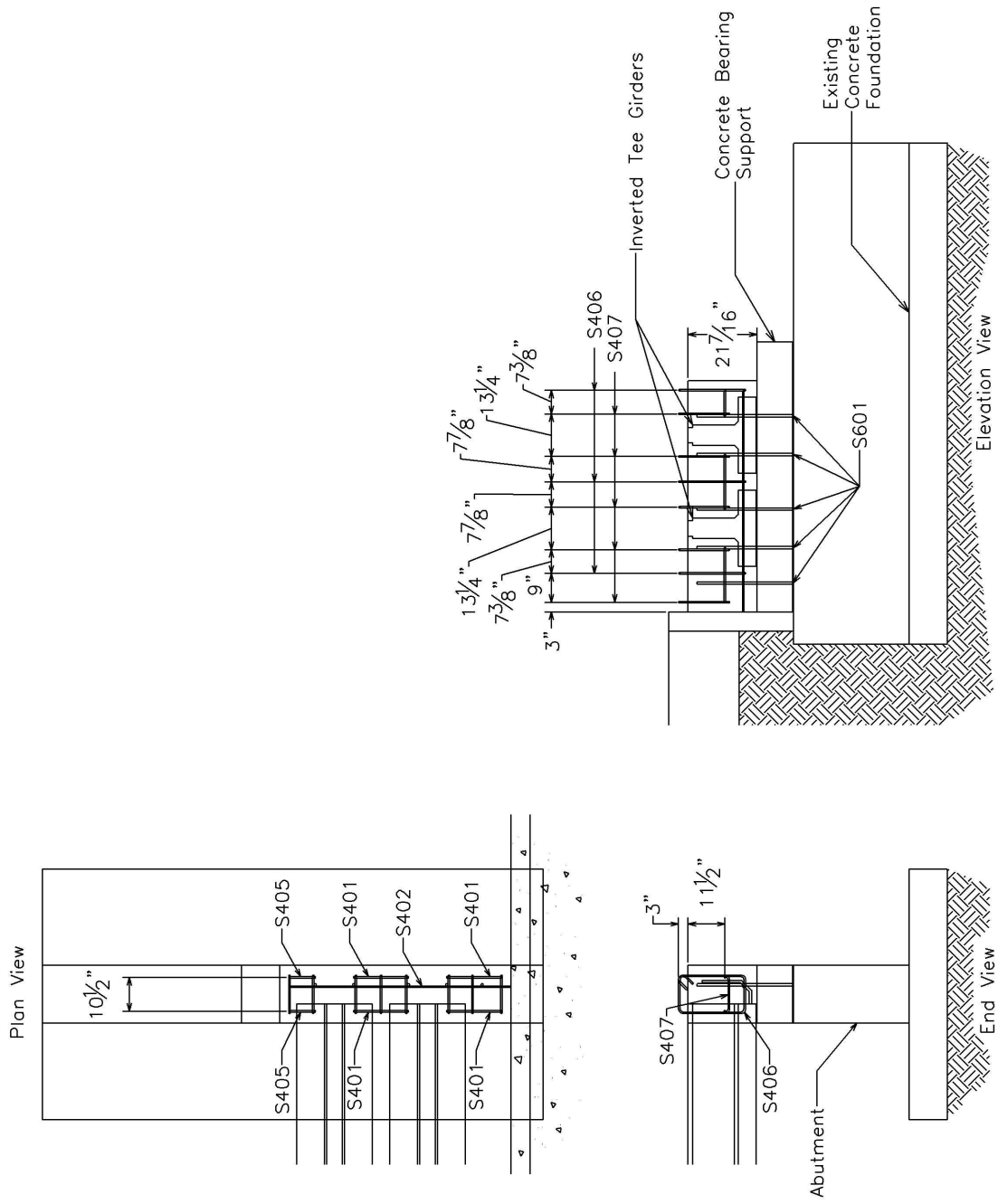

Figure A-5. Abutment Joint Details (English)

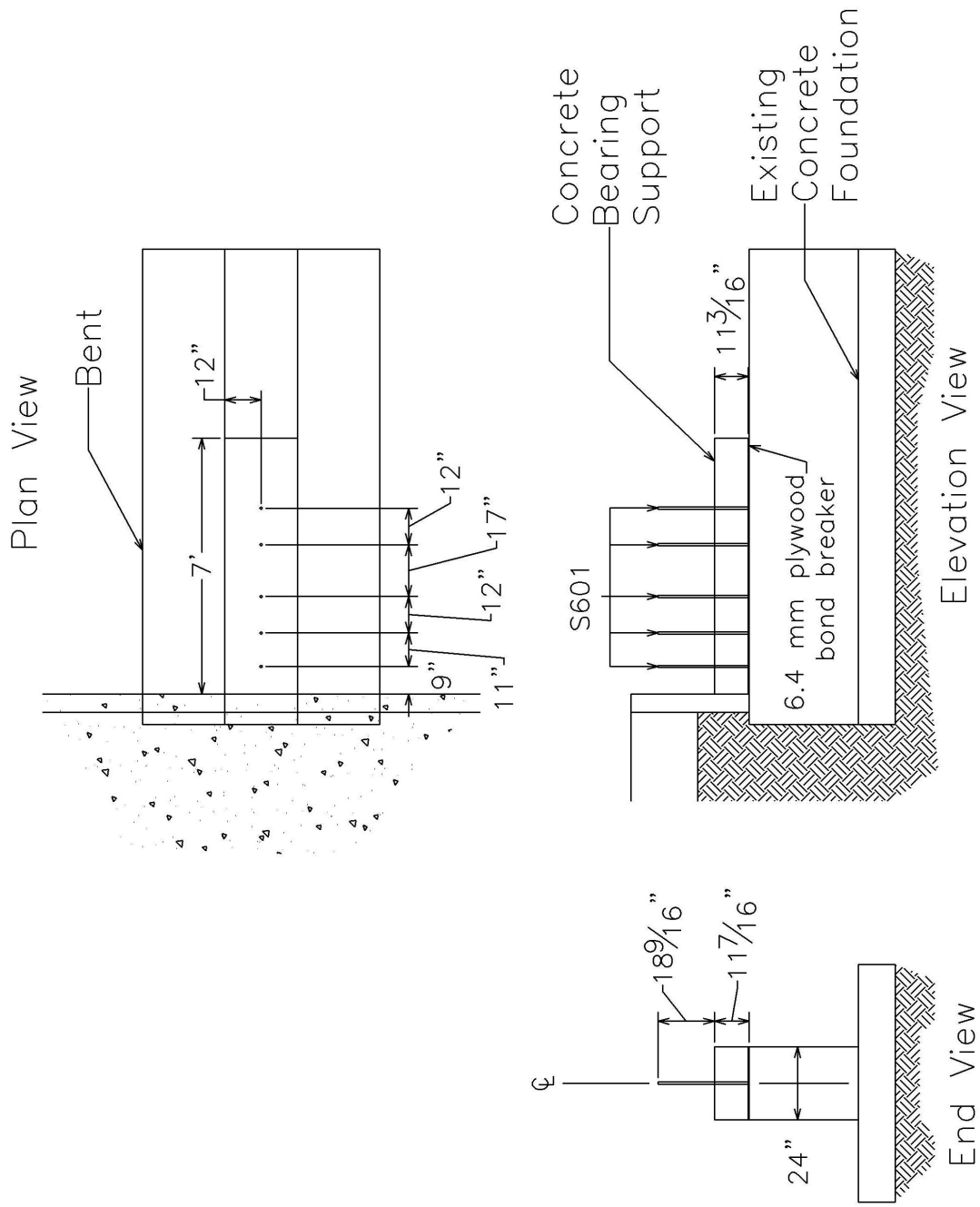

Figure A-6. Bent Details (English)

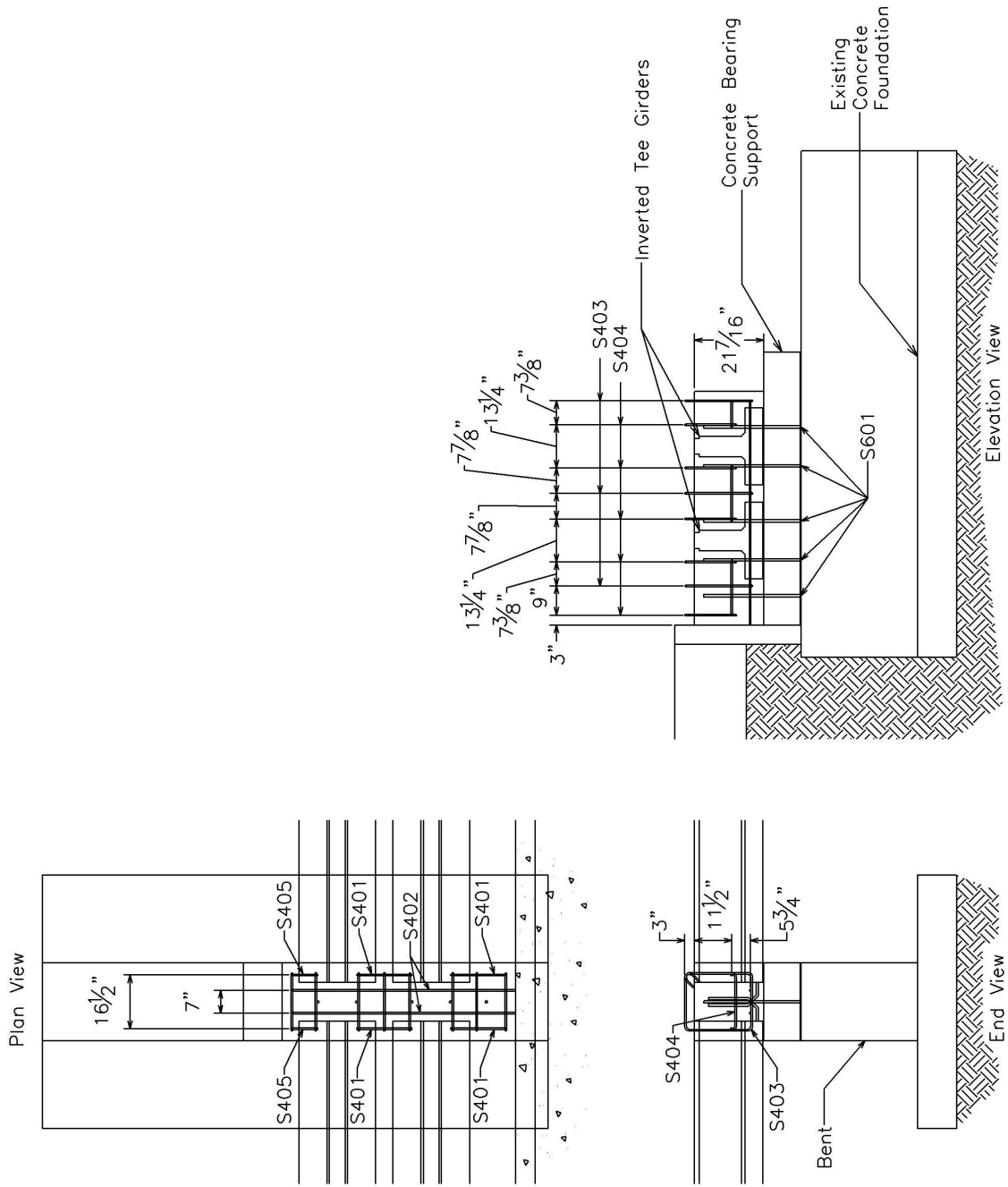

Figure A-7. Bent Joint Details (English)

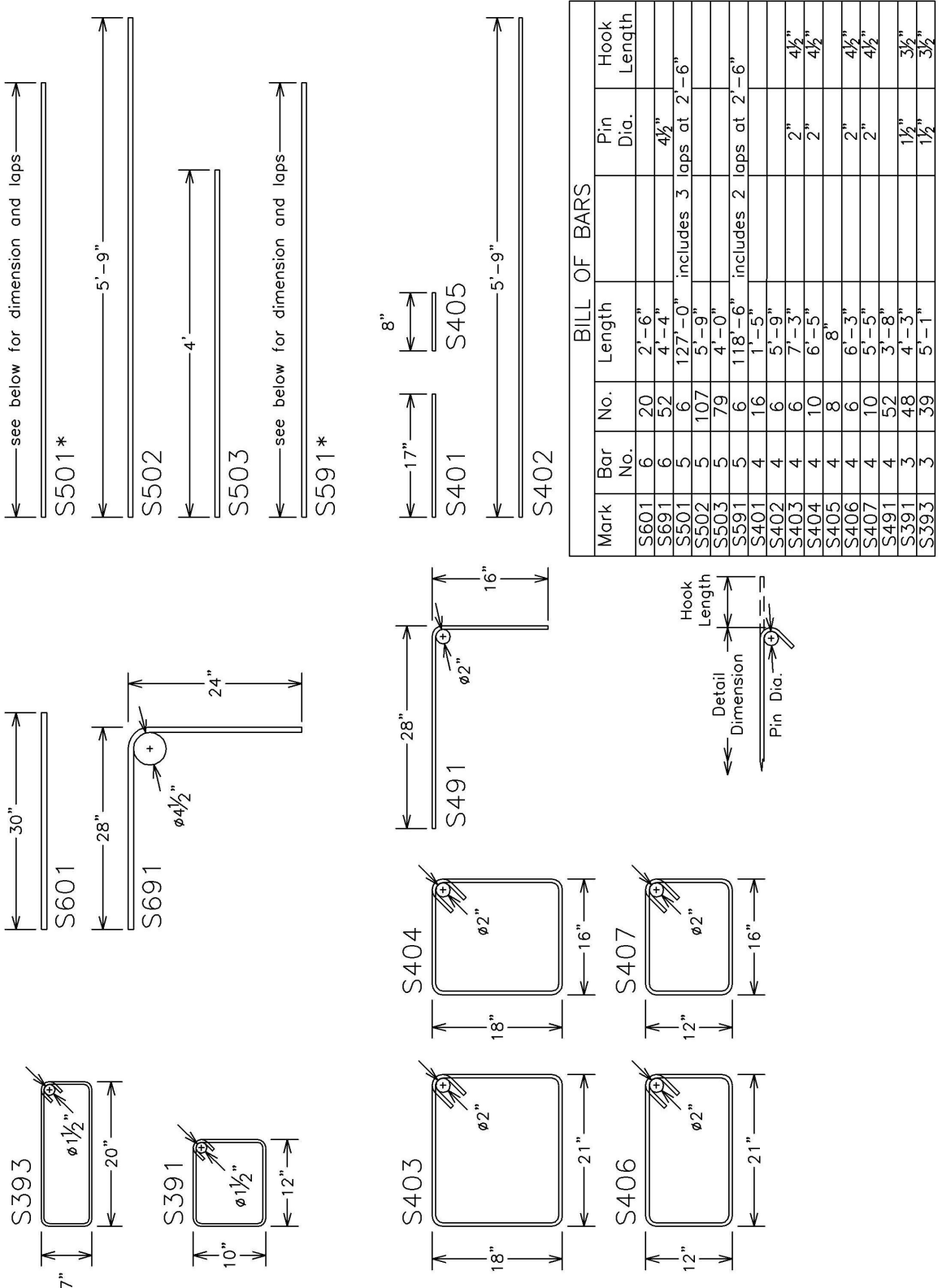

Figure A-8. OCR Bridge Rail on Inverted Tee Bridge Deck Bill of Bars (English)

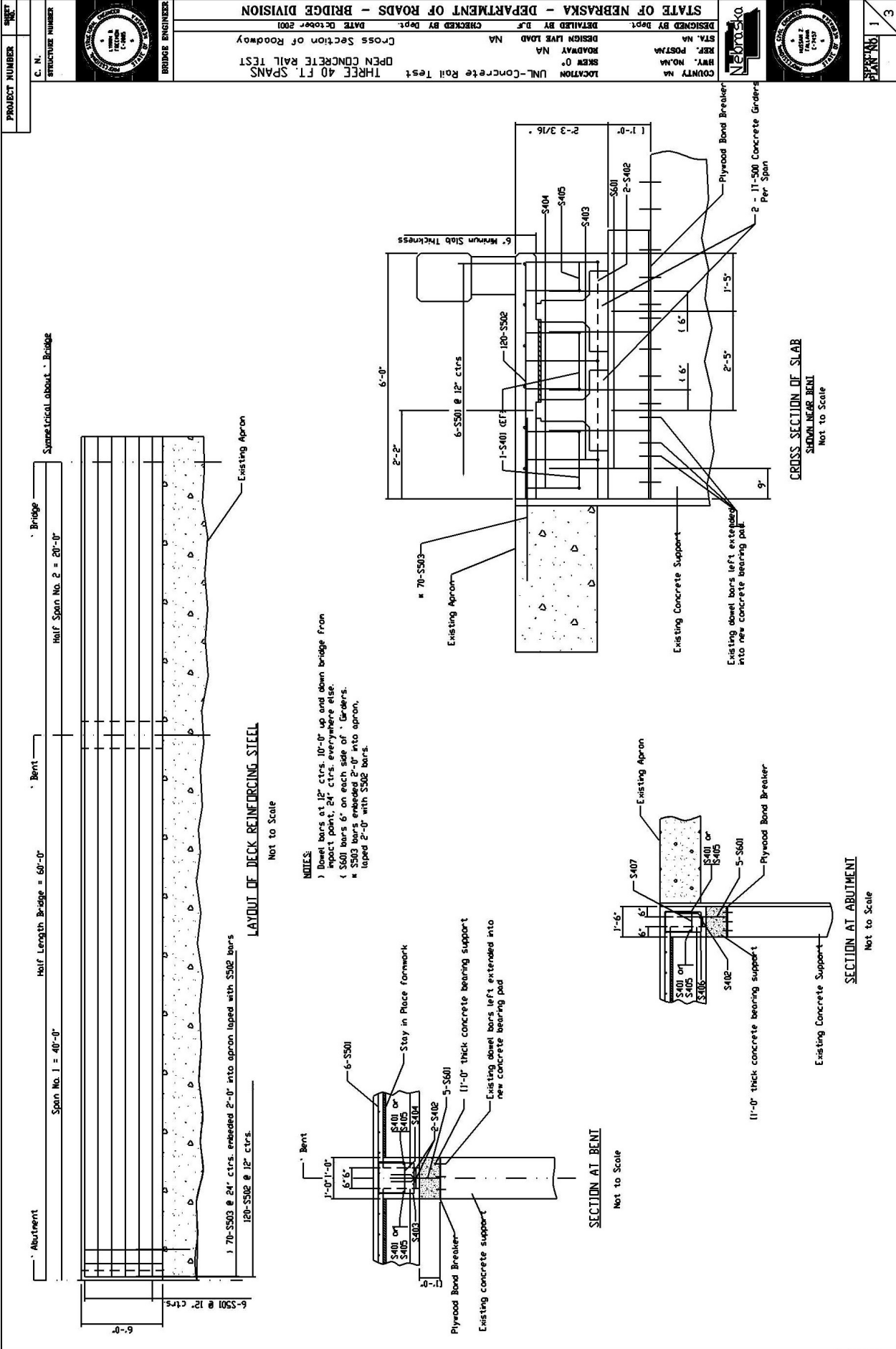

Figure A-9. NDOR's Bridge Deck Standard Plan (English)

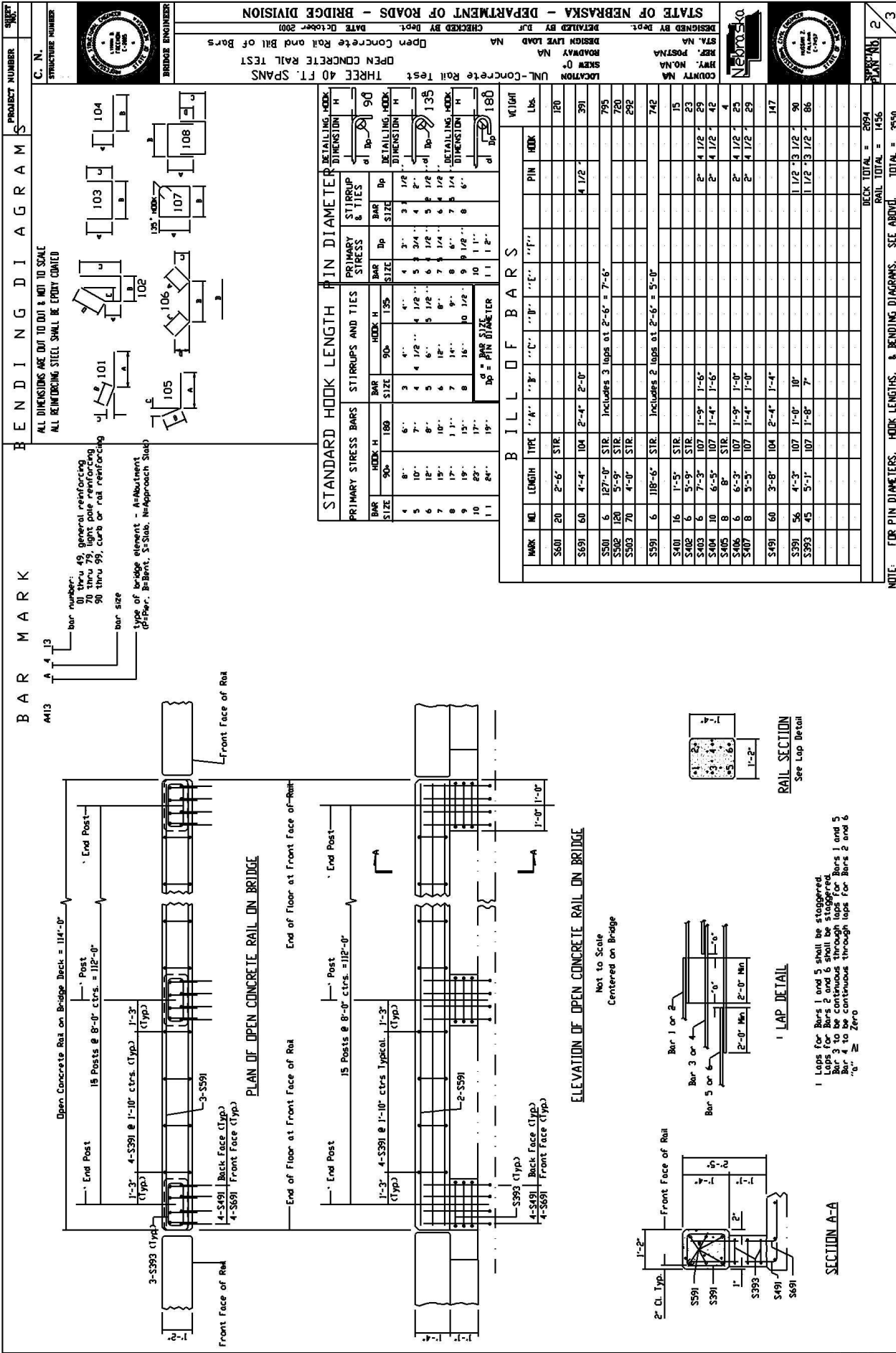

Figure A-10. NDOR's Open Concrete Bridge Rail Standard Plans (English)

COMPOSITE PROPERTIES				NON-COMPOSITE PROPERTIES				COMPOSITE PROPERTIES				SUPERIMPOSED LOADS				
SPAN NO.	GIRDER LENGTH (feet)	CONCRETE STRENGTH (psi)	RELEASE PER DAYS AT	GIRDER AREA (sq. ft.)	GIRDER MOMENT OF INERTIA (in ⁴)	MOMENT OF INERTIA (in ⁴)	RELEASE PER DAYS AT	SECTION MODULUS (in ³)	SECTION MODULUS (in ³)	SECTION MODULUS (in ³)	SECTION MODULUS (in ³)	SECTION MODULUS (in ³)	SECTION MODULUS (in ³)	SECTION MODULUS (in ³)	SECTION MODULUS (in ³)	
																1
1	39'-0"	5000	7000	3	1.77	2,301	2,209	6.77	6,955	0.188	0.32	0.008	0.192	0.252	0.288	0.3
2	39'-0"	5000	7000	3	1.77	2,301	2,209	6.77	6,955	0.188	0.32	0.008	0.192	0.252	0.288	0.3
3	39'-0"	5000	7000	3	1.77	2,301	2,209	6.77	6,955	0.188	0.32	0.008	0.192	0.252	0.288	0.3

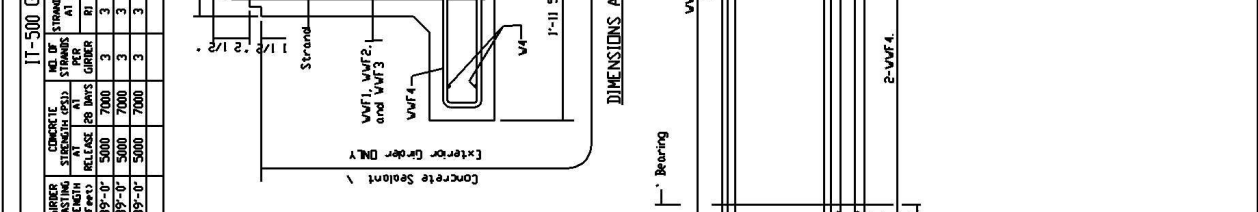
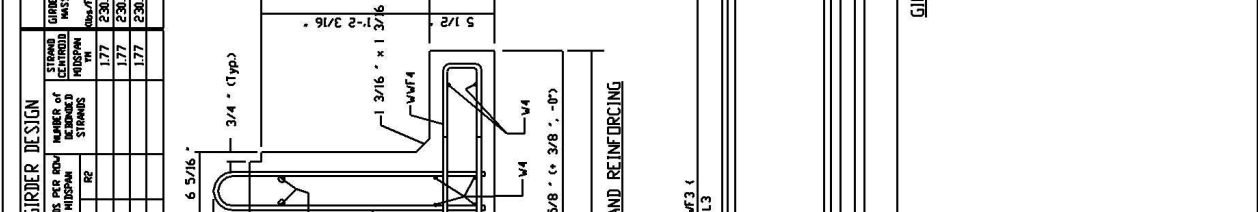
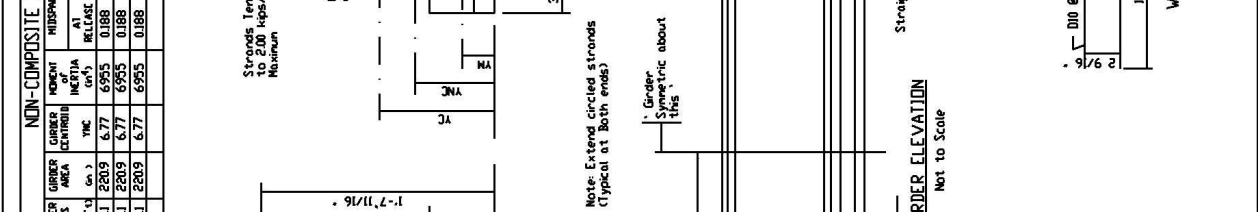
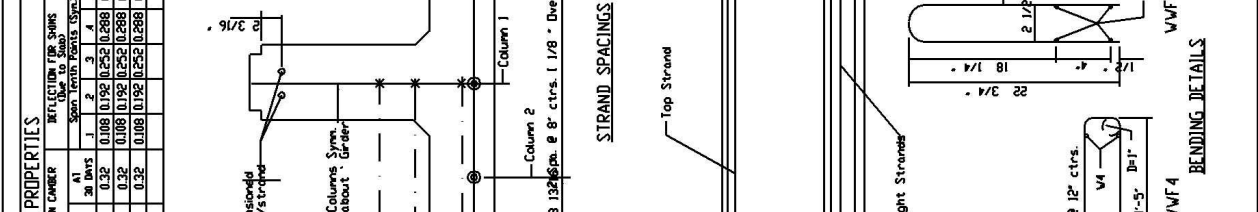
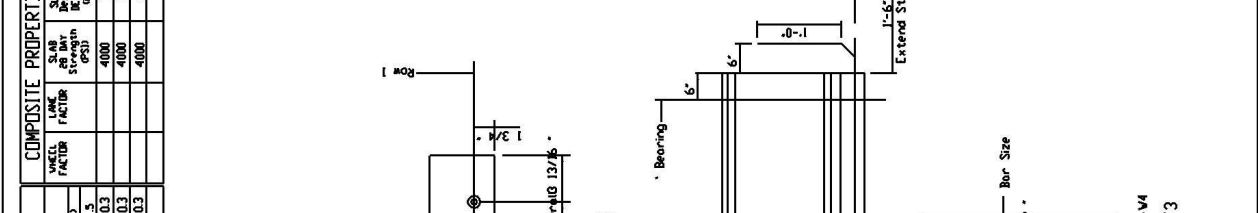
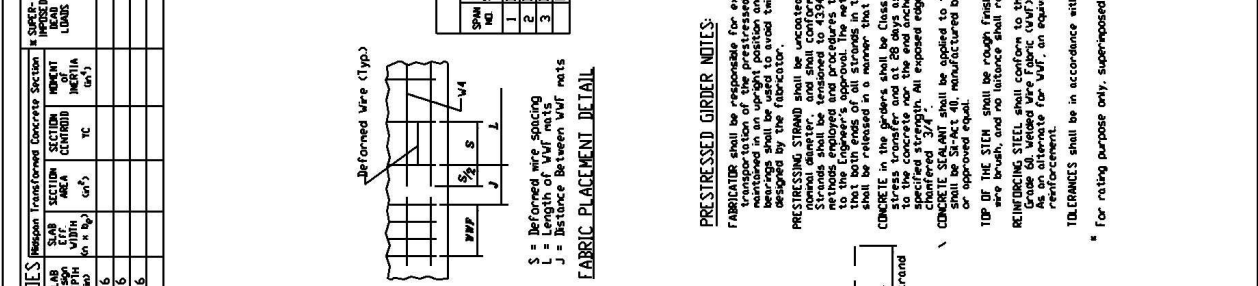
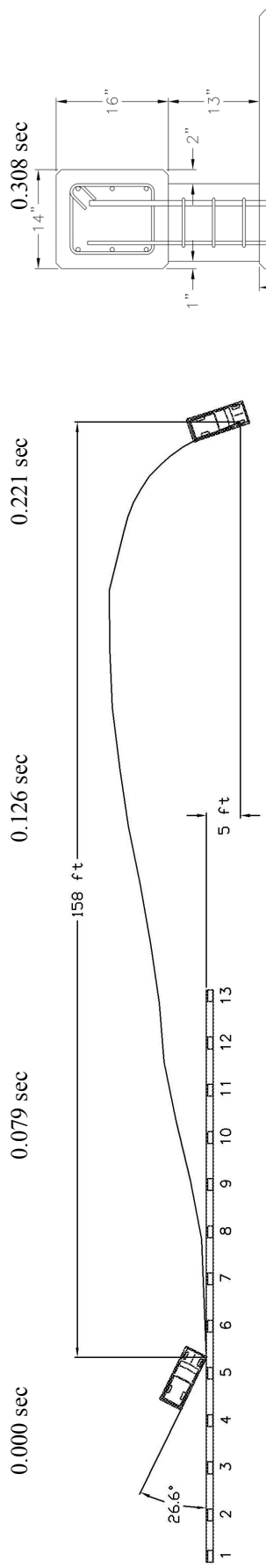

Figure A-11. NDOR's Inverted Tee Standard Plans (English)

APPENDIX B

Test Summary Sheet in English Units, Test NIT-1

Figure B-1. Summary of Test Results and Sequential Photographs (English), Test NIT-1



● Test Number	NIT-1	● Vehicle Speed	62.0 mph
● Date	3/20/02	● Impact	49.7 mph
● Appurtenance	Nebraska's Open Concrete Bridge Rail Attached to an Inverted Tee Bridge Deck System	● Vehicle Angle	26.6 deg
● Total Length	104.8 ft	● Impact	est. 13-15 deg
● Concrete Material	Nebraska 47-BD Mix	● Exit	None
● Reinforcing Steel Material	Grade 60 Rebar - Epoxy Coated	● Vehicle Snagging	None
● Concrete Bridge Rail		● Vehicle Pocketing	None
Length	97 ft	● Vehicle Stability	Satisfactory
Width	14 in.	● Occupant Ridedown Deceleration (10 msec avg.)	6.29 G's < 20 G's
Depth	16 in.	Longitudinal	7.75 G's
Top Mounting Height	29 in.	Lateral (not required)	
● Concrete Bridge Posts		● Occupant Impact Velocity	21.65 ft/s < 39.37 ft/s
Length	24 in.	Longitudinal	25.43 ft/s
Width	11 in.	● Vehicle Damage	Moderate
Height	13 in.	TAD ⁹	I-RFQ-4
Spacing	96 in.	SAE ¹⁰	I-RFEW4
● Concrete Bridge Deck		● Vehicle Stopping Distance	158 ft downstream
Length	104.8 ft	● Barrier Damage	5 ft laterally behind
Width	72 in.	● Maximum Rail Deflections	Moderate
Thickness	6 in.	Permanent Set	NA
● Vehicle Model	1995 GMC 2500 ¾-ton pickup	Dynamic	0.9 in.
Curb	4,327 lbs	● Working Width	23.1 in.
Test Inertial	4,445 lbs		
Gross Static	4,445 lbs		

Figure B-1. Summary of Test Results and Sequential Photographs (English), Test NIT-1

APPENDIX C

Occupant Compartment Deformation Data, Test NIT-1

Figure C-1. Occupant Compartment Deformation Data, Test NIT-1

VEHICLE PRE/POST CRUSH INFO

TEST: NIT-1
 VEHICLE: 1995 GMC 2500 PU

POINT	X	Y	Z	X'	Y'	Z'	DEL X	DEL Y	DEL Z
1	53.5	1.25	2.5	52.5	1.25	5.5	-1	0	3
2	54	7.25	2.5	52.5	7.25	6.5	-1.5	0	4
3	56.5	11.25	1.25	56.5	10	4.25	0	-1.25	3
4	60	16.5	0	60.5	14.5	2.5	0.5	-2	2.5
5	59.75	23	0.25	59	20.5	4	-0.75	-2.5	3.75
6	58.75	28.75	1	56.5	26.5	4.5	-2.25	-2.25	3.5
7	47	3.5	-0.25	45.5	3.5	2	-1.5	0	2.25
8	46.5	9.25	-3.5	45.25	8.5	-0.75	-1.25	-0.75	2.75
9	49.75	15.75	-6.5	48.75	13.5	-3.75	-1	-2.25	2.75
10	49.5	12.5	-6.75	48.75	21.25	-6	-0.75	8.75	0.75
11	37.5	0.75	-0.5	36.5	0.75	1	-1	0	1.5
12	38	10.25	-5.5	37	8.75	-5.25	-1	-1.5	0.25
13	40.25	16.25	-6.25	39.75	14.25	-3.25	-0.5	-2	3
14	40.25	24.25	-6.5	39.75	22.25	-5.25	-0.5	-2	1.25
15	38	29.25	-7.25	38.75	27.5	-7.5	0.75	-1.75	-0.25
16	30.25	2	-1.25	29	1.75	0.5	-1.25	-0.25	1.75
17	30.75	12.25	-6	30	11.5	-4	-0.75	-0.75	2
18	31	24.25	-6	30.5	23.25	-4.5	-0.5	-1	1.5
19	23.75	14.5	-6	23.5	14	-4.25	-0.25	-0.5	1.75
20	23.5	21.25	-6.25	23.75	20.75	-5	0.25	-0.5	1.25
21	23.75	28.75	-6.75	24	29.5	-5.75	0.25	0.75	1
22	29.5	32.25	0	28	32.25	1	-1.5	0	1
23	42.25	25.25	18	41.75	25.25	20	-0.5	0	2
24	43	16.5	18.5	42.75	16.5	20.25	-0.25	0	1.75
25	41.25	1.25	26	41.25	1	27.5	0	-0.25	1.5
26									
27									
28									
29									
30									

ORIENTATION AND REFERENCE INFO

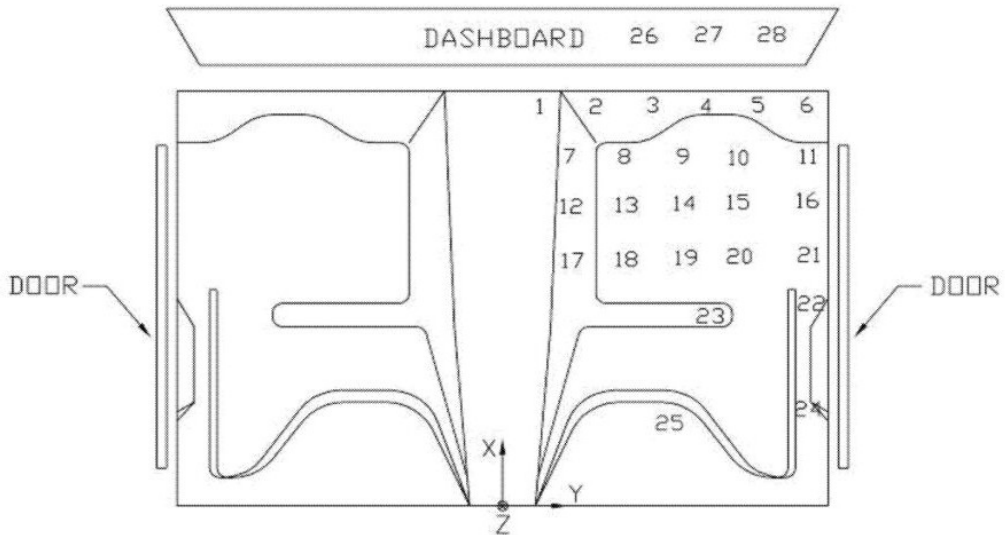

Figure C-1. Occupant Compartment Deformation Data, Test NIT-1

APPENDIX D

Accelerometer Data Analysis, Test NIT-1

Figure D-1. Graph of Longitudinal Deceleration, Test NIT-1

Figure D-2. Graph of Longitudinal Occupant Impact Velocity, Test NIT-1

Figure D-3. Graph of Longitudinal Occupant Displacement, Test NIT-1

Figure D-4. Graph of Lateral Deceleration, Test NIT-1

Figure D-5. Graph of Lateral Occupant Impact Velocity, Test NIT-1

Figure D-6. Graph of Lateral Occupant Displacement, Test NIT-1

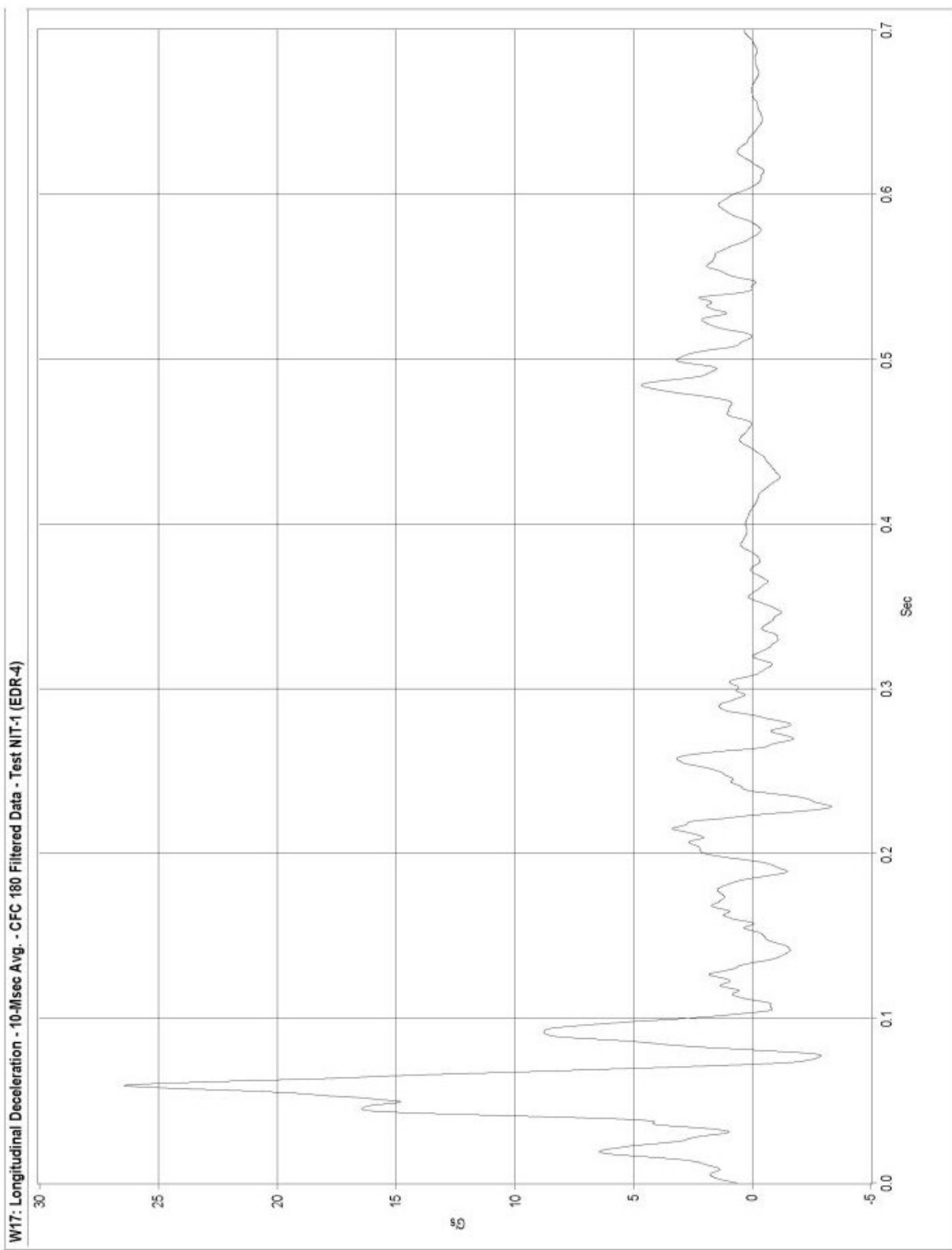

Figure D-1. Graph of Longitudinal Deceleration Test NIT-1

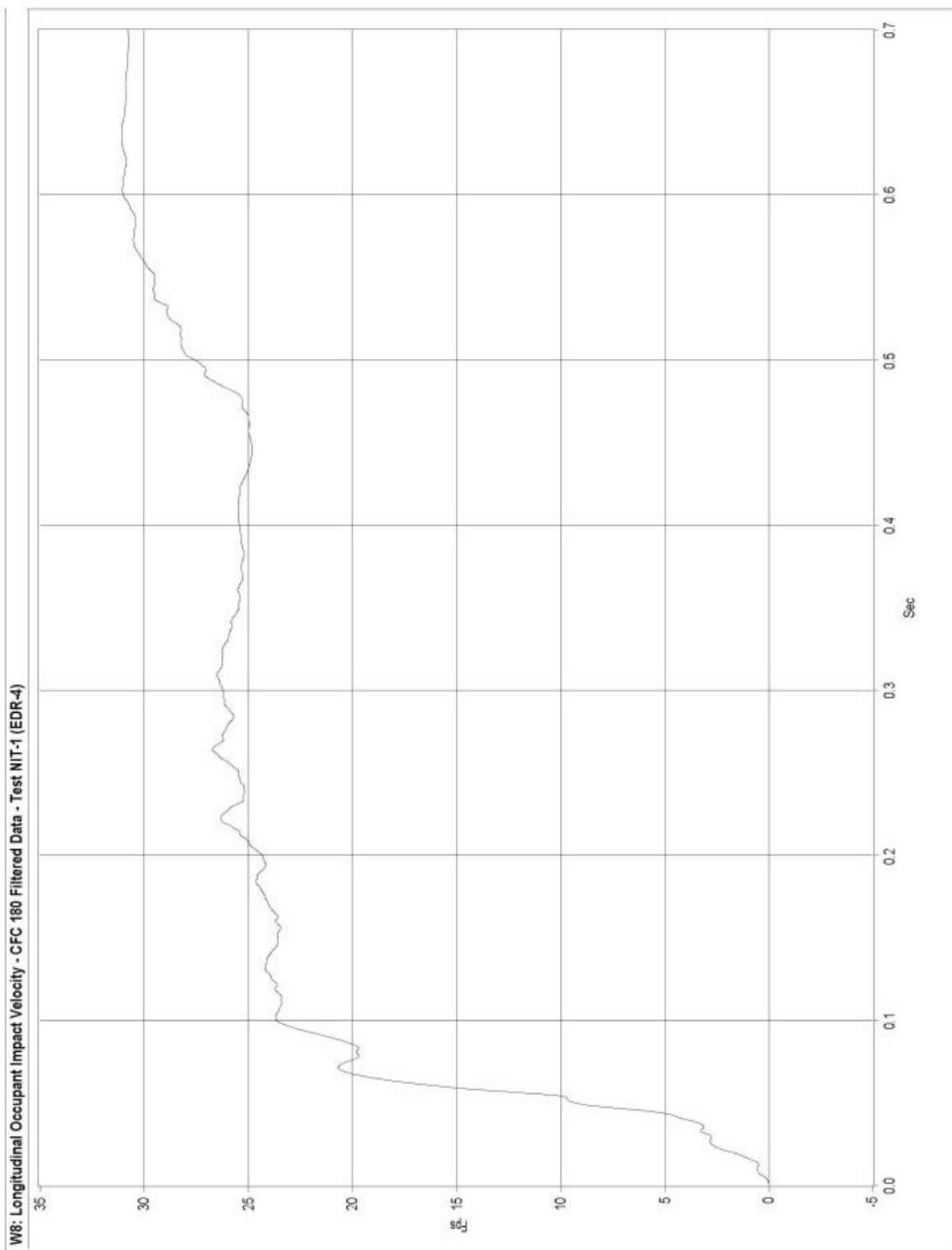

Figure D-2. Graph of Longitudinal Occupant Impact Velocity, Test NIT-1

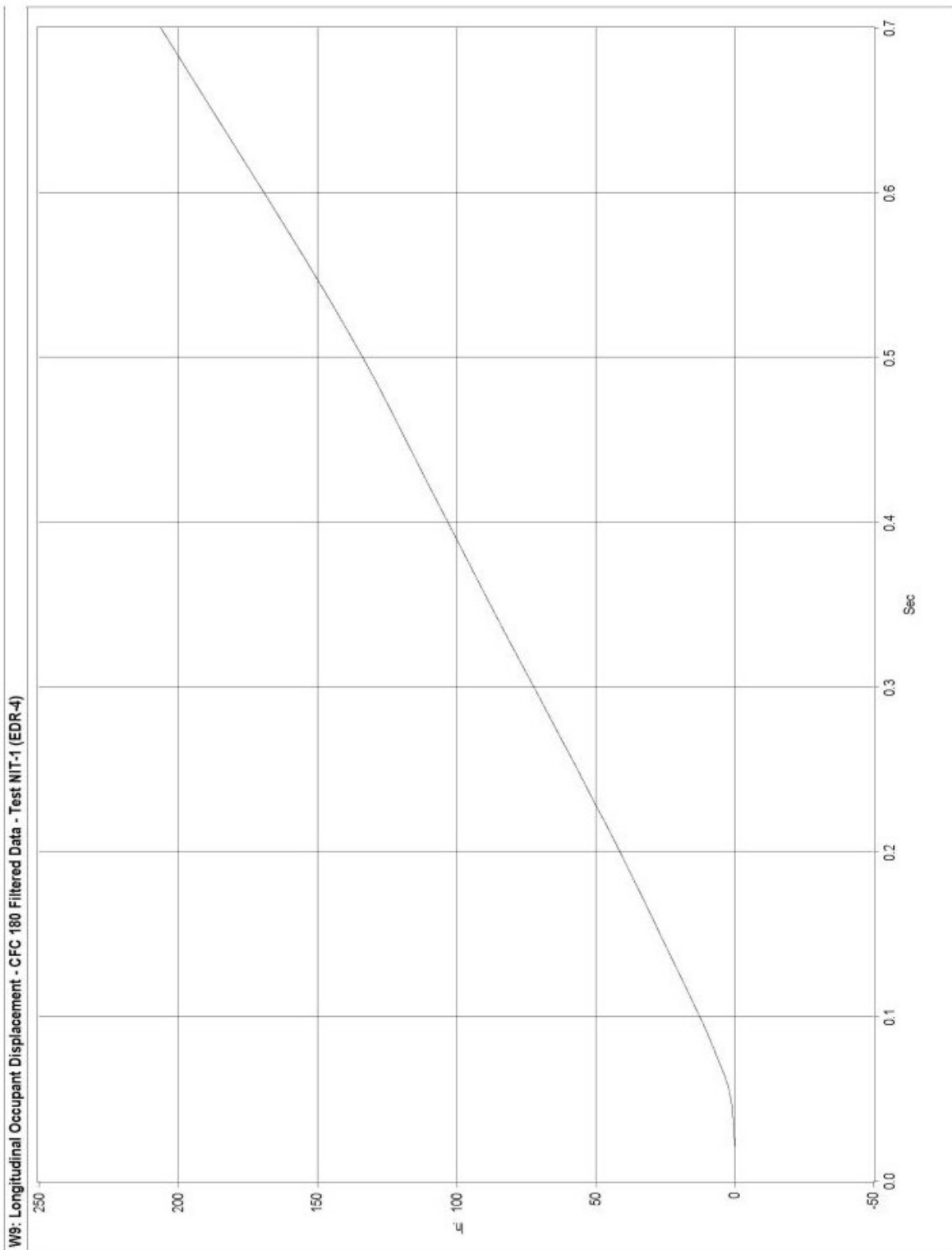

Figure D-3. Graph of Longitudinal Occupant Displacement, Test NIT-1

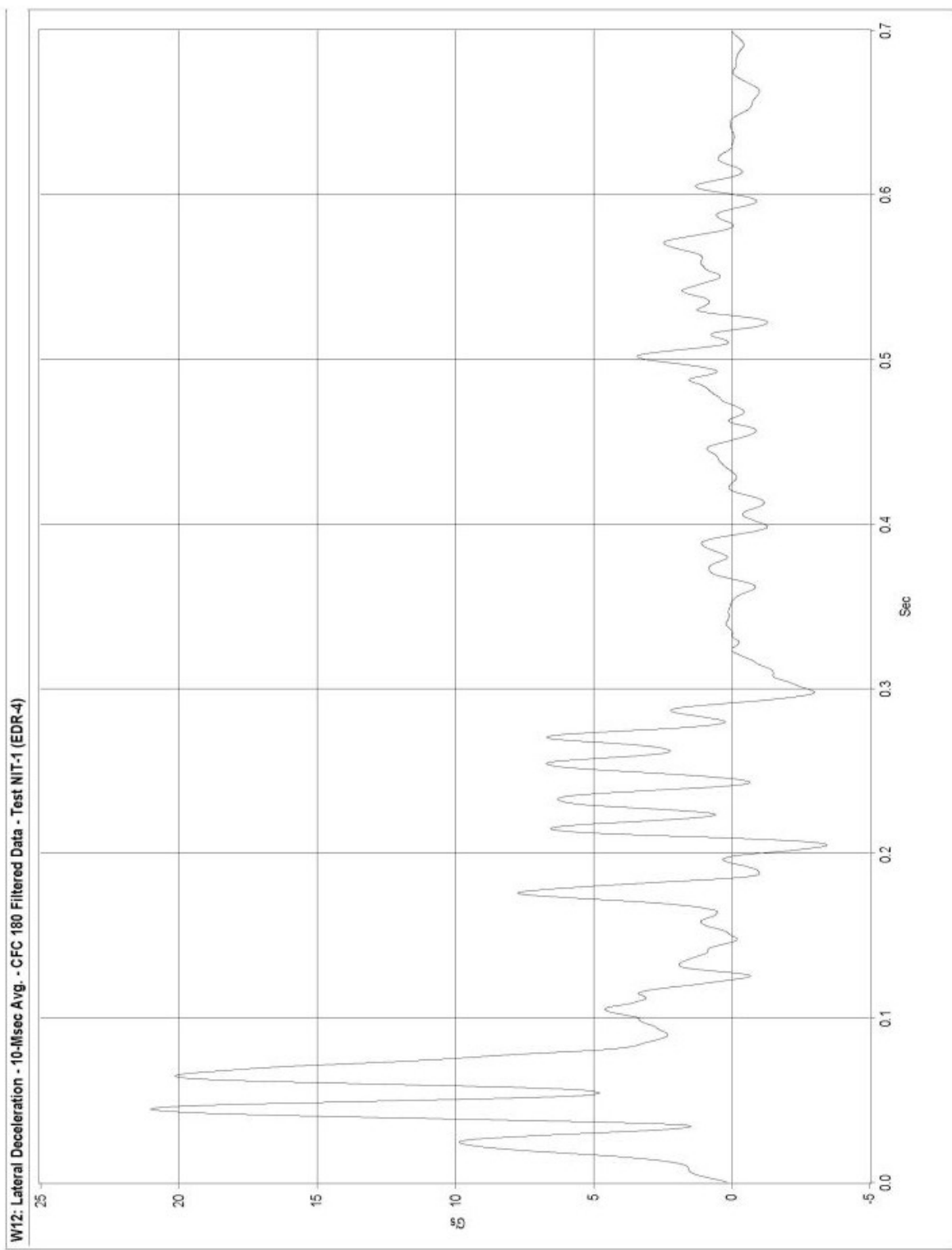

Figure D-4. Graph of Lateral Deceleration, Test NIT-1

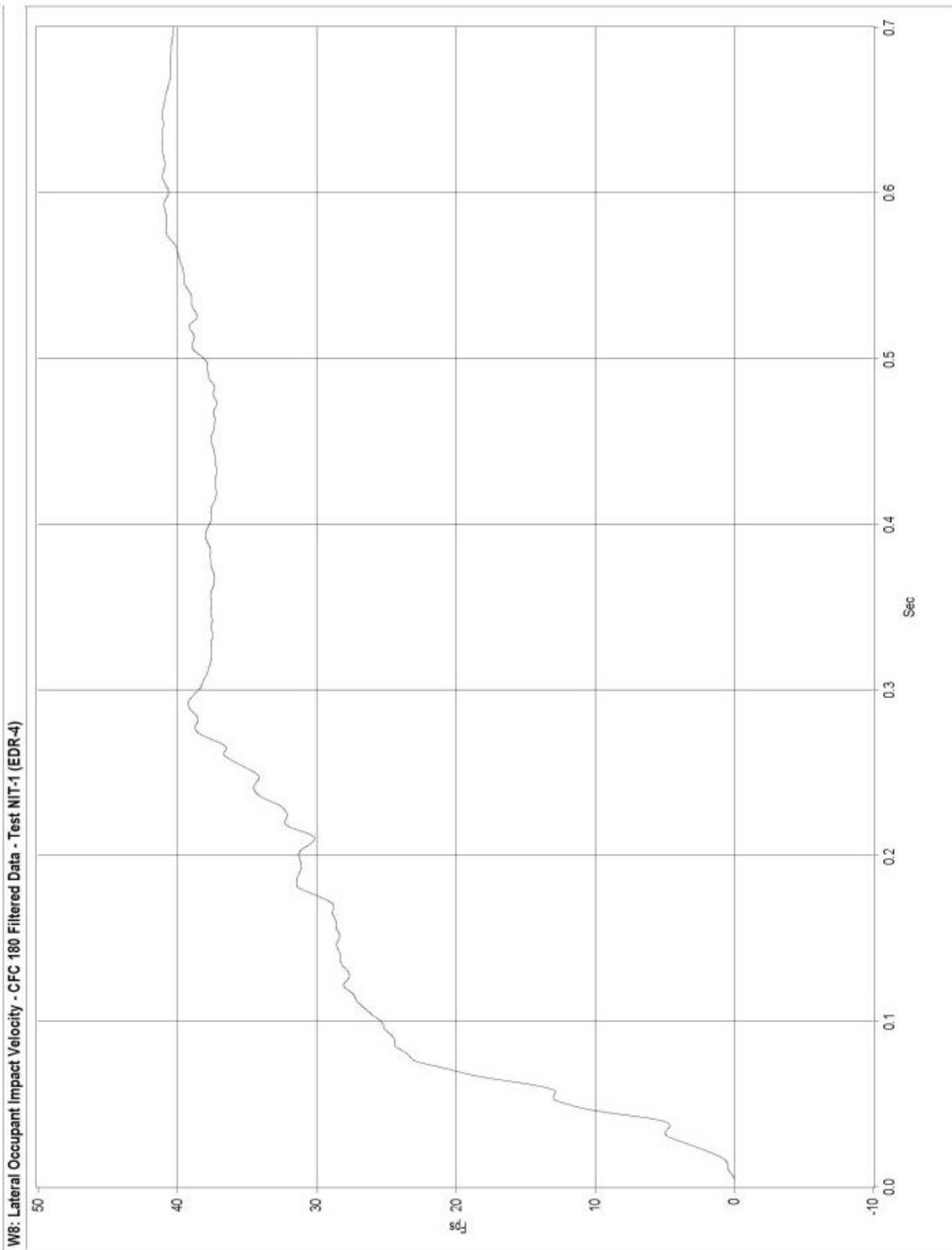

Figure D-5. Graph of Lateral Occupant Impact Velocity, Test NIT-1

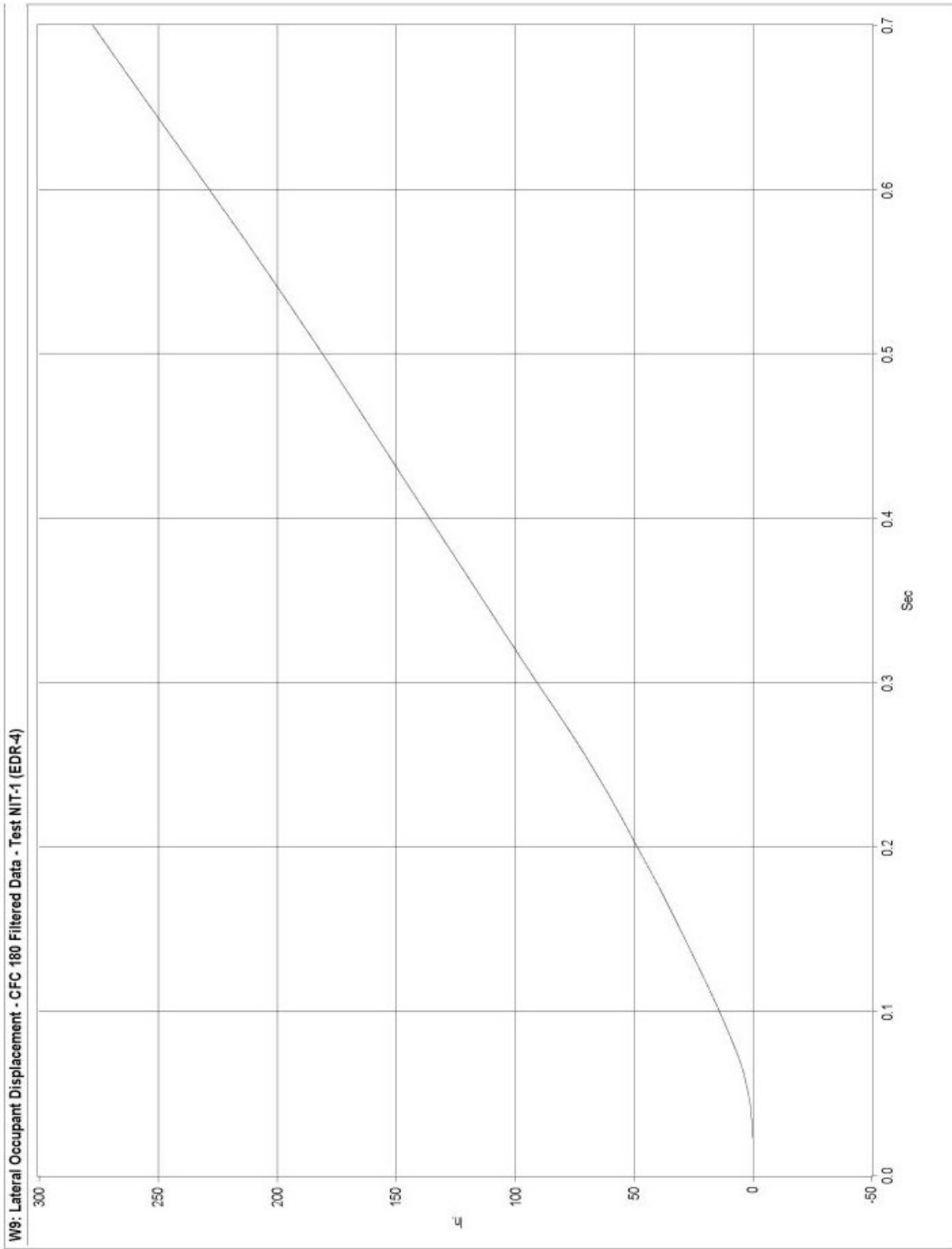

Figure D-6. Graph of Lateral Occupant Displacement, Test NIT-1

APPENDIX E

Roll and Yaw Data Analysis, Test NIT-1

Figure E-1. Graph of Roll Angular Displacements, Test NIT-1

Figure E-2. Graph of Yaw Angular Displacements, Test NIT-1

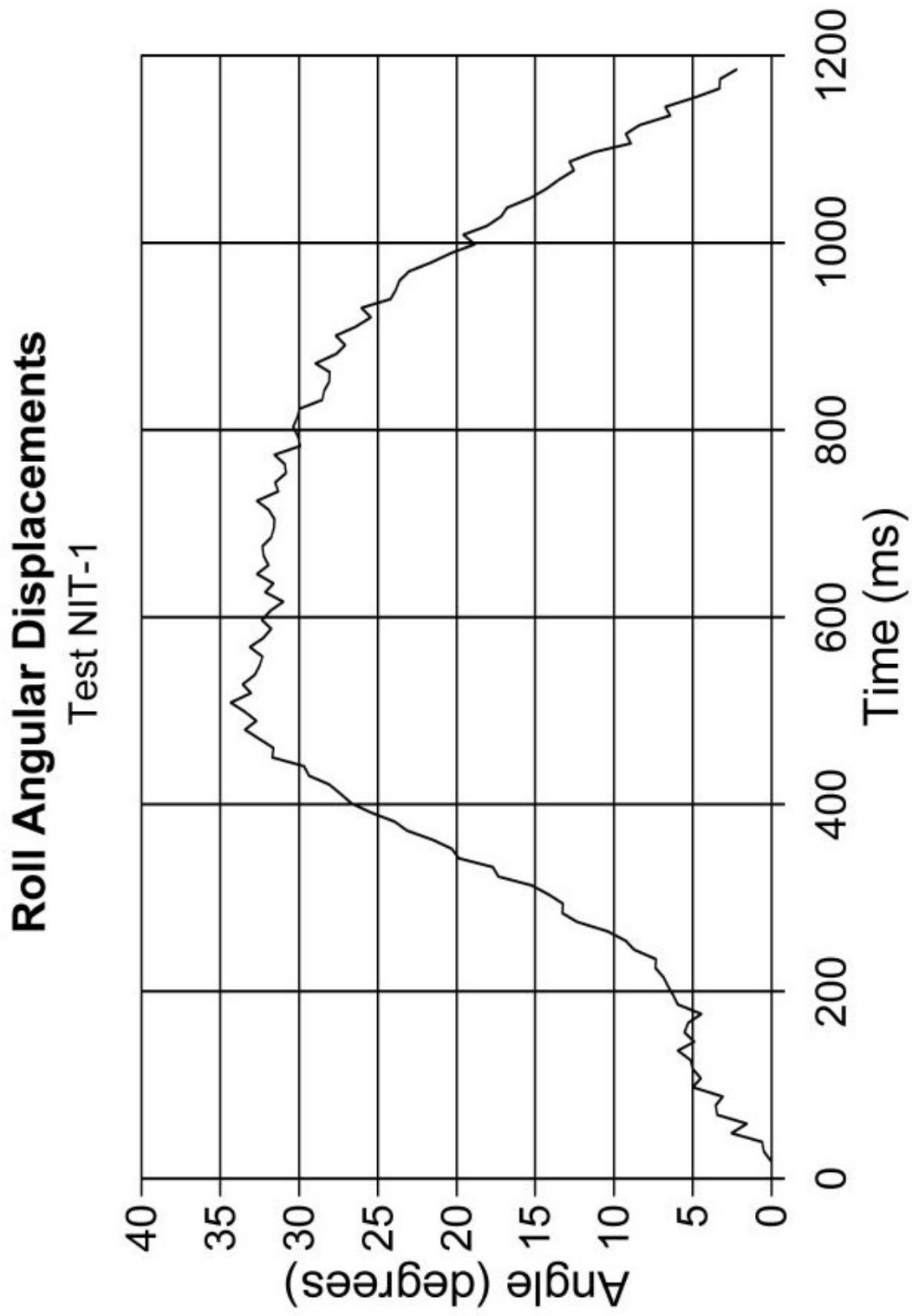

Figure E-1. Graph of Roll Angular Displacements, Test NIT-1

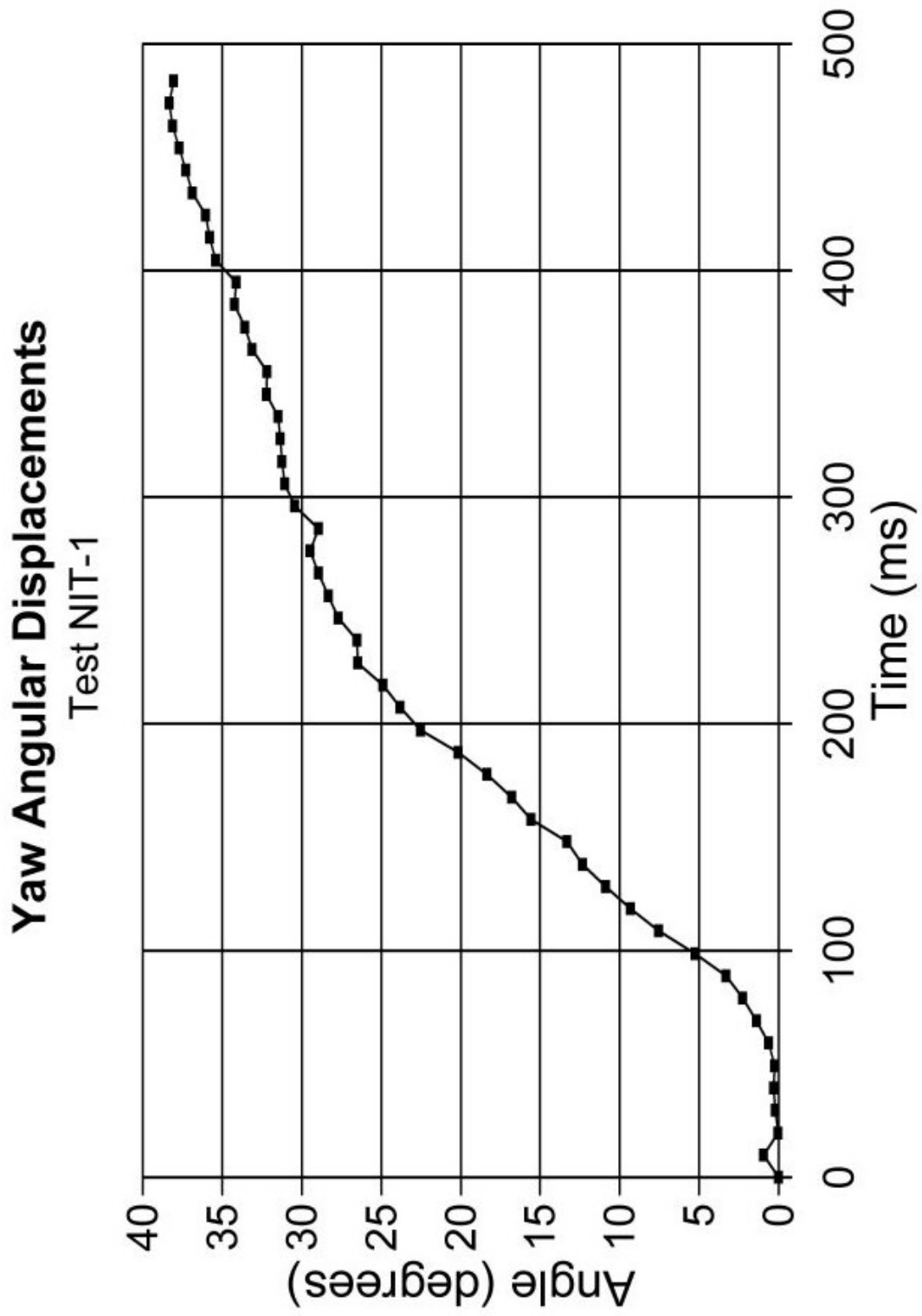

Figure E-2. Graph of Yaw Angular Displacements, Test NIT-1